

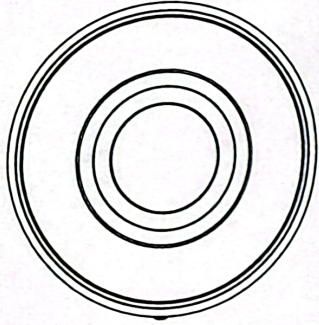

# DPQ360

## Installation Instructions



Ceiling Mount Quad Detector

[www.pima-alarms.com](http://www.pima-alarms.com)

## Key Features

- Quad Element Pyro
- 2.4m – 4.0m Mounting Height
- Grade 2
- Free-form Fresnel lens<sup>†</sup>
- Selectable EOL Resistors
- Remote LED Control
- Sealed Optics
- Digital Pulse Count<sup>†</sup>
- Temperature Compensation
- Advanced Signal Processing<sup>†</sup>
- RFI Immunity up to 2.7GHz

<sup>†</sup>Patent Pending

## 1 Location

### Location Warning

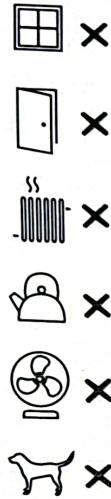

### Coverage Pattern

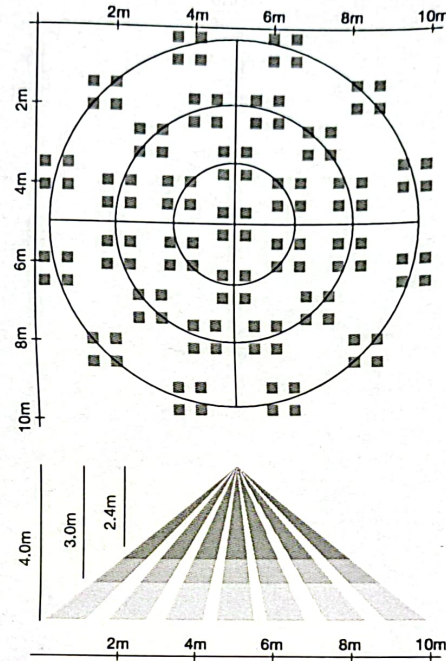

## 2 Mounting

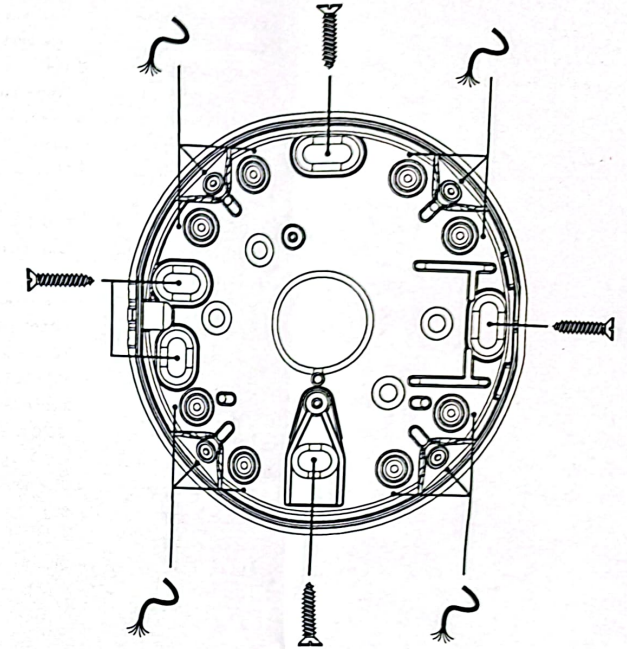

## 3 Detector Setup

Note the jumper settings for installation with FORCE.

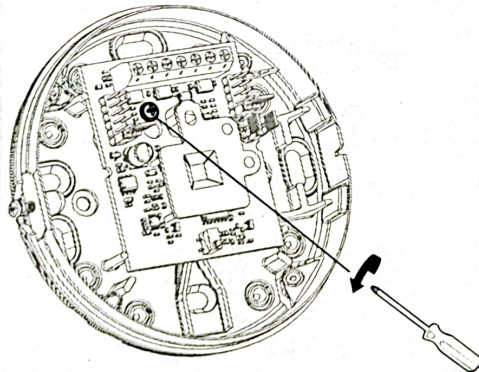
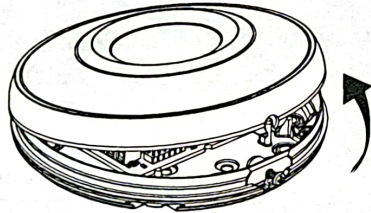

### For Double Pole Wiring

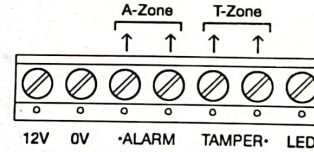

### For EOL Wiring

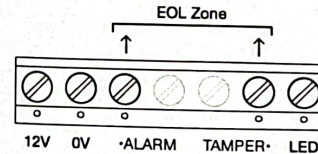

### Alarm Resistor

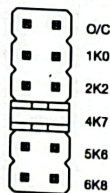

### Tamper Resistor

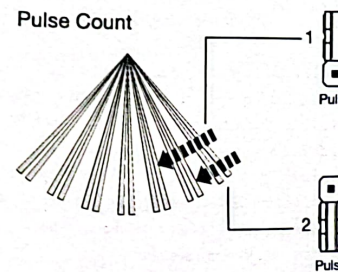
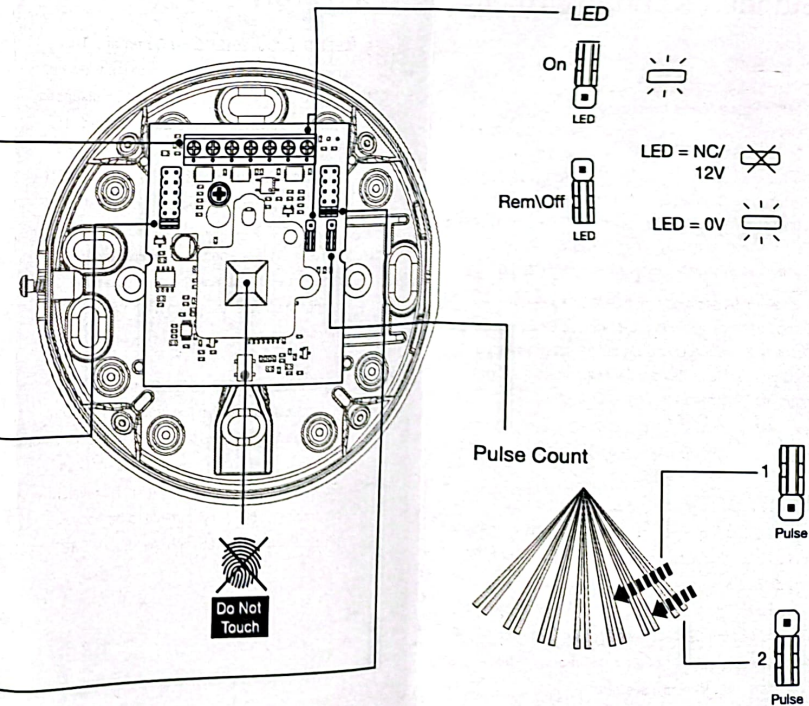
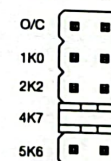

Do Not Touch

## 4 FORCE Settings

Set the FORCE Alarm System as follows:

- Two EOL resistors
- Resistor values – 100 (=10K)
- Alarmed zone – EOL protected

## Specification

Description	360 PIR Detector
Pyro Electric Sensor	Quad Element
Optics	Free-form Fresnel
Detection Areas	124
Mounting Height	2.4m - 4.0m
Supply Voltage	9 - 15Vdc (12V nominal)
Quiescent Current	10mA
Alarm (LED enabled)	15mA
Alarm (LED disabled)	7mA
LED Control = 0V	LED Enabled
LED Control = 12V / NC	LED Disabled
Pulse Count	Digital
Start-up Time	60 seconds
Alarm Time	> 2 seconds
Target Speed	0.3m/s - 3.0m/s
Dimensions (whd) mm	108 x 108 x 31
Housing Material	3mm ASA
Operating Temperature	-20°C to +55°C
Storage Temperature	-35°C to 60°C
Maximum Humidity	95% non-condensing
Product Weight	90g
Packed Weight	115g
Maintenance	Annual Installer Check

## Ordering Information

CAT. P/N	5010157
Description	DPQ360 Ceiling PIR Detector

## Standards and Approvals

### Security

PD 6662:2017

EN 50131-2-2:2021 Grade 2, Class II

### EMC / False Alarm Immunity

EMC Immunity: EN 50130-4:2011

+A1:2014

Radiated Immunity: 80MHz to 2.7GHz

Electrostatic Discharge: +/- 8kV

Conducted Immunity: 0.15MHz to 100MHz

Fast Transient Immunity: 2kV

Conducted & Radiated Emissions: EN 55022:2010

Hereby, PIMA declares that the DPQ360 conforms to: European Union (EU) Electro-Magnetic Compatibility (EMC) Directive 2014/30/EU and EN 50130-4:2011+A1:2014  
EMC Environment: Residential / Commercial / Light Industrial / Industrial



EU & UK Registered Design

## Warranty

The DPQ360 is guaranteed against defects in material or faulty workmanship for a period of 10 years from the date of purchase.

Disclaimer: PIMA will not accept any liability based on a claim that the DPQ360 failed to perform correctly as it is a component part of an installation and not a complete intruder alarm system.

## Regulatory



WEEE Directive: 2012/19/EU Compliant: This symbol indicates that according to local laws and regulations, this product should not be disposed of as municipal/household waste. Instead, it should be disposed of at the appropriate collection points designated for the recycling of electrical and electronic equipment, or returned to PIMA upon purchase of new replacement products. This will help to conserve natural resources and ensure that it is recycled in a manner that protects human health and the environment.

RoHS RoHS Directive: 2011/65/EU Compliant: PIMA declares that this product complies with and conforms to RoHS legislation that it does not contain more than the agreed levels of: Lead (Pb), Cadmium (Cd), Mercury (Hg), Hexavalent chromium (Cr6+), Polybrominated biphenyls (PBB), Polybrominated diphenyl ethers (PBDE)

# PIMA

Designed and Manufactured  
in the United Kingdom

PIMA Electronic Systems Ltd.  
5, Hatzoref St., Holon 5885633, Israel  
Tel: +972.3.6506411  
Email: support@pima-alarms.com  
<http://www.pima-alarms.com>

4410567 Rev A (Dec 2022)

