

KCV-T701SM MANUAL

[7" Digital Color LCD Videophone]

AHD CCTV Compatible GUI Full Touch Videophone



- 7" Digital LCD Screen (NTSC/PAL)
- Simple and Convenient UI & Full Capacitive screen
- Compatible with 1080p (FHD) AHD CCTV (TVI, AHD, CVI)
- Auto still image capture (Max 32 cuts) Door Camera
- Connection up to 2 Door Cameras and 4 Monitors with Sub-interphone (KIP-32G)
- Overall or individual calling available
- Multifamily, Apartment application (KLP-C420 SYSTEM)

Cautions for safety







For safe use, please stick to the following cautions.

- Please do not dispose this manual after reading the instructions carefully.
- Please read all instructions to set up rightly.
- This Cautions for Safety may include items that are not contained in specifications of the product that consumer purchases.

The important marks in the manual.



To help our customers to understand this manual, to prevent any personal injury or property damage, some marks are used in the manual. The marks and the drawing signs are below. Please, understand the marks before reading the manual.

The meaning of the drawing signs.



- | | |
|--|---|
|  Sign to show what not to do. |  Mishandling the device with ignoring this sign may result in serious injury or death. |
|  Mishandling the device with ignoring this sign may result physical injury or material damage. | |
|  Sign to tell you that you should follow the instructions. |  Sign to tell you that you must unplug the unit. |
|  Sign to tell you that you can't disassemble this unit. | |

Caution

Cautions for set-up



- The law limits distributing the power wire to an authorized person from government. The work from an unauthorized person cause fire or electric shock.
 -  Place this unit securely on a stable surface. Serious damage and/or injury may result if the unit falls.
 - Do not set up this unit near the leaking place because it may expose you to dangerous voltages or other risks.
 - Even if your product is water proof, do not install it slanted place of water leakage, which can a short circuit.
 - Fix the product on the wall safely according to the installation guideline to prevent any damage or injury.
 - The disconnect device shall remain readily operable.
-
- The work of distributing wires needs skills and experiences. So please, for assistance, contact your dealer or call service center.
 - The communication wire should be built in being distant from the power source.
 -  This may result in the risk of fire, electric shock and communication disorder.
 - Setting the communication wire in a high humid place such as outside without any protection from rain causes the communication disorder.
 - Keep the hook at the wall-mounted device safe. The hook may cause the physical injury.
 - Think about the thickness and quality of wall material. The unqualified material may make the device fall.
-
-  Set the device of the wall-mounted type not to fall. Falling from an earthquake causes personal injury.

Cautions for Repairs and Maintenance

-  Keep the inside of the device clean. Having the dust inside without any cleaning for a long time causes the fire. If necessary, contact your dealer or service center to get cleaning service.
 - Unplug this device when you want to check the inside, if there is no plug, please, turn off the circuit breaker.
 -  Unplug this device when you try to move it to another place.
 - If the electric line is connected inside of the unit, please contact your dealer or service center.
-
-  Do not use liquid or aerosol cleaners. Use a damp cloth for cleaning.

Warning

Warnings for Usage

- Do not install this unit near the water and dust, for example, in a bathroom or near the washing machine. It caused fire and electric shock.
 - Do not install this unit near the fire, for example, near kitchen sink, heater or the like.
 - Do not install near the noxious gas such as Hydrogen Sulfide, metal powder and the like.
 - Do not install near the water and chemicals.
 - Do not give any damage, break and modify the plug. Overloading, heating, pulling causes the damage.
 -  Do not place the plug near the heater. The damaged code causes fire and electric shock. Do not pull the power code when unplugging.
 - The damaged code causes fire and electric shock. Must pull with plug. Do not touch with wet hands. It causes the electric shock.
 - Do not use any other voltage, except the marked regular voltage.
 - Do not use the power terminal at the units to other electric device except the designed device.
 - Do not install the units at the leaking place if it doesn't have any waterproof mark. Do not install the unit when the power is on.
 - Install the circuit breaker after checking the safety such as electric shock and leakage. Turn off the power before you install or A/S
-
- Check the suitability of the wire for installing when you use the exiting wire.
 - Do the wiring work by using the designed material.
 -  Connect the electric wire with the designed ways and ground.
 - Do not connect with any other devices except the designed devices to compose the system.
-
-  Unplug electric wire and communication wire from the units before relocate the product.

ⓘ Cautions for Use

- This unit is not designed for security purpose.
- Do not handle the unit with the wet hands.
- Do not place a pot with water or a small metal material on the Units.
- Do not cover the ventilating opening or put any metal material in the units.
- During thunderstorms, avoid using this unit. There may be a remote risk of an electric shock from lightning.
- Any changes or modifications to the equipment not expressly approved by the party responsible for compliance could void user's authority to operate the equipment.



- Do not disassemble the back and cabinet cover.

ⓘ Cautions for Abnormality

- Change the damaged electric code.
- Unplug this unit from plug socket and refer servicing to an authorized service center when the following conditions occur:
 - If liquid has been spilled into the unit.
 - If the unit does not work normally by following the operating instructions.
 - If the unit exhibits a distinct change in performance.
 - If the unit has been dropped or physically damaged.



Caution

ⓘ Safety Instructions, Warnings and Cautions of Each System

- Do not disassemble this unit as will as this device is composed by precision parts.
- Install the unit by following the set-up instructions of Kocom.
- Do not touch or insert any foreign substances, for example, sticker, magnetic, opener and the like.
- Make U-type at the end of wires as the rain can effect on the system by following the wires during the rainy season.

ⓘ Videophone

- Separate the AC/DC wire with the hook of the wall-mounted type when installing.
- Connect the wire after peeling the wires properly.
- Do not distribute signal line with AC line.
- Use the designed driver to connect the wire to terminal.
- Do not clean the LCD with the damp cloth for cleaning. Use the only dry and soft cloth.
- Do not install the main gate monitor at the leaking place.

ⓘ Things You Need to Know

- This product is designed as a home videophone and cannot use continuously like monitor camera.
- If there is temperature difference between inner part of camera and surrounding, dew condensation occurs on camera lens and may disturb image. If dew condensation is removed from camera lens, image quality recovers.
- White LED light examination range is narrower than camera shot range at night, so there is less amount of light at night than day. So it is difficult to see the face in low illumination condition due to noise increase on screen, but it is not from defect.
- Monitor screen (liquid crystal panel) is not in defect when some pixels always light or black out.
- Please install monitor and camera over 5cm away.
- Also, avoid installing at a place with too much noise, because too much noise around camera causes phone call inferiority.
- Do not place an object within 20cm in front of monitor. It causes phone call inferiority, especially because microphone is installed at the top of monitor.
- If strong light such as sunlight flows into camera module, screen saturation (or strange mark) and image shaking might occur.
- This is not a defect, so please do not install camera where a direct ray of light do not flow if possible.

ⓘ Cautions

- In some cases there is occurrence of product destruction, malfunction, noise mixing and picture quality deterioration due to mixing of other tools induced, voltage or thunder with communication wiring of monitor/camera, monitor/extended monitor.
- Do not wire with power line such as outdoor wiring or AC power, or phones and other tools.
- You cannot use it if you incorrectly wire the AC voltage between monitor/camera, monitor/extended monitor.
- Call the store or agency where you purchased this product and consult to solve the problem.
- Beware that unfixable damage might be caused due to authorizing AC voltage on communication wiring of monitor/camera, monitor/extended monitor.
- Do not ever disjoint this product. It may cause electrocution accident when touching high-voltage circuit inside this product.
- Outside power authorizing this product must be confirmed of product description and use rated voltage.
- Beware that if higher voltage is authorized, unfixable damage might be caused due to product destruction.
- Power must be connected to domestic voltage (product rated voltage) consent or interior wiring.
- If connected to other motive power or inverter-type power, product destruction, noise mixing, and picture distortion may occur.
- Do not drop this product. Glass is used for monitor and might break, or cause other circuit inferiority.
- In such case, immediately turn down the power switch, and call to consult agency or store in which this product was purchased.
- Keep away from any conditions where water splatters or falls. Do not place anything containing water like a vase on the product.
- If you install a product nearby an antenna used for broadcast media, image could be distorted or mixed with a voice so that it is likely not to work properly in some functions.
- Avoid installing near tools with strong electromagnetic waves such as microwaves and cell phones, as it may cause a picture distorted or a voice with a noise. In that case, the product is likely not to work properly in some functions.
- Do not install monitor in following places.
 - ① Above or around water heater, rice-cooker, heater
 - ② Place exposed to direct rays of the sun
 - ③ Place with temperature below 0°C such as cold store
 - ④ Place with high humidity such as bathroom, washroom, heated room
 - ⑤ Place with a lot of gas, dust, smoke
 - ⑥ Dangerous place with sprays of water or chemicals
- Do not wipe with insecticide, drugs or chemicals such as thinner and alcohol, or it may damage the surface of this product.
- Beware of occurrence of image quality deterioration or malfunction from cause of humidity due to penetration of chemicals or water into camera's urea resins.
- As in the picture, it prevents temperature difference of camera (outside) and monitor (inside), and removes dew condensation caused by humidity of camera window.
- Camera must be installed when wall cement is completely dry.
- When product is installed in winter below -5°C, wait for approximately 2 hours to connect. Dew formation in monitor and camera due to temperature difference inside and outside may cause product defect.
- Avoid installing monitor and camera in place directly exposed to heat or where gas noxiousness is highly occurring.

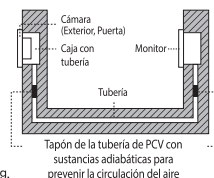

Installation Location

■ Monitor installation location

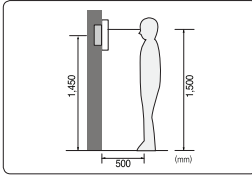

· Recommended installation height is about 1,500mm where screen center is at eye level. In this case, wall-hanging metal center (center of piping) is 1,450mm above ground level.

■ Camera installation location

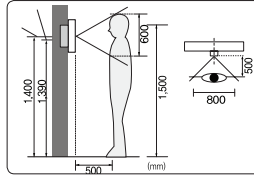

· Recommended installation height of door camera is where lens is about 1,400mm above the floor. In this case, camera stack center (Buried box) is above 1,390mm above ground level.

■ Caution of camera installation

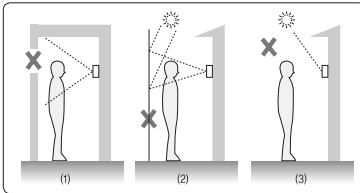

- Avoid installing camera exposed to direct sunlight or lights.
- Back light or shadow on visitor's face may occur difficult recognition.
- Avoid installing camera in places such as the following picture.
 - (1) Place illuminating sky as background
 - (2) Place with white wall reflecting direct ray of light
 - (3) Place with direct ray of light

■ Monitor installation

■ Directly connecting cut-off power cord with power wire

- 1) Personal electrical work must be avoided. Please find local installer or electrician for installation.
- 2) power cords must be insulated with insulation tape after the work.
[Exposed wires may cause fire or electric shock.]
- 3) Highly recommend to cut main power supply off before electrical work.

- 1) Remove metal wall hanger bracket behind monitor.
- 2) Install metal wall hanger bracket on 1 type box or wall with attached screw.
- 3) Connect wiring to monitor back terminal referring to product connection diagram.
- 4) Hang monitor on metal wall hanger bracket
- 5) Test the product status if the monitor is both plugged in and switched on.

■ Door camera installation

KC-Q81P(D1)

KC-MC24(D1)

KC-S81M(D1)

KC-MC30M(2M,AHD)

KC-MC20(D1)

Surface mount type

Flush mount type

※ When using angle supporter, if main body screw(4x18) does not fit, please use spare screw(4x20)

※ After fix the rear bracket with 4 screw, put the Door Camera into the grooves of rear bracket, and then fix it with hexagon screws and stick the finishing materials.

Components of Product

■ Monitor



■ Screws



Adapter(CT-140200 or UT60-140210-6-02)

■ Wall hanger



4X25mm 4ea

■ Wire

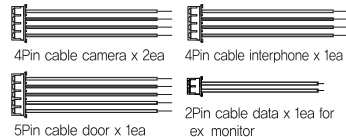

■ Door Camera

[KC-Q81P(D1)]



Bracket

Sun visor



Finishing rubber



Screws for fixing camera main body supporter

4X10mm

■ Door Camera

[KC-S81M(D1)]

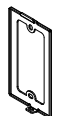
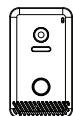

Bracket

[Option]

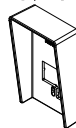

M3X8mm 1EA

4X50mm 2ea

Lench 2,5mm 1EA

[KC-MC30M(2M,AHD)]



Bracket



Wall to bracket screws

4X25mm



Camera to bracket screw

4X8mm



"L" wrench



screw cover (KC-MB30)

[KC-MC24(D1)]



Bracket



Finishing rubber



Screws for fixing camera main body supporter



Screw for fixing camera



4X16mm

[KC-MC20(D1)]

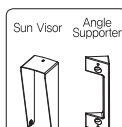

Sun Visor

Angle Supporter

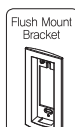

Flush Mount Bracket

Screws Cover (2EA)

Sun visor screw (2X4mm 3EA)

Bracket screw (4X25mm 2EA)

Main Bbody screw (4X18mm 2EA)

※ In case of Surface mount type, 'Sun Visor' and 'Angle Supporter' are packed together with the 'product'. Flush mount type includes 'flush mount bracket'.

Specifications

	Model No.	KCV-T701SM AC TYPE		KCV-T701SM DC TYPE		
Monitor	Power Source	100-240V~, 50/60Hz		DC 14V-2A		
	Power Consumption	1.7W(±20%)(On Stand by), MAX 14W(±20%)(Full load)				
	Operating Temperature	0°C ~ +40°C				
	LCD	7 inch LCD				
	Communication Type	HandsFree Type				
	Input / Output	Door camera : 2mm pitch 4Wire x 2 Door Open : 2mm pitch 5Wire x 1		Interphone : 2mm pitch 4Wire x 1 Inner DATA : 2mm pitch 2Wire x 1		
	Maximum wiring distance (UTP CAT5e or Coaxial)	Door camera to last VDP —— 100m (The IN-OUT wiring must be done) CCTV to VDP —— 100m (When using Coaxial cable (RG59)) Interphone to VDP —— 10m ※ Refer to "product wiring" below for cable wiring ※ UTP CAT5e : The resistance of 100 m of cable should be 10 ohms or less.				
	Mount Type	Surface mount				
	CCTV Type	Analog HD Type (TVI, CVI, AHD), (720p, 1080p)				
	Still image Capture	Max 32 cuts (Still cut images are stored in internal memory.)				
Dimension	218(W) X 119(H) X 22(D) mm		218(W) X 119(H) X 18(D) mm			
Door Camera	Model No.	KC-Q81P(D1)	KC-MC30M(2M,AHD)	KC-MC24(D1)	KC-S81M(D1) KC-MC20(D1)	
	Power Source	DC 12±1V(Power from Monitor)				
	Power Consumption	Max. 3W				
	Operating temperature	-10°C ~ +50°C				
	Dimension(mm)	75(W) x 136.5(H) x 18.5(D)	110(W) x 158(H) x 39(D)	96(W) x 127(H) x 32(D)	70(W) x 125(H) x 21(D)	40(W) x 120(H) x 22(D)
	Viewing angle	Diagonal 90° (angle adjustable)	Diagonal 100° (angle adjustable)	Diagonal 90°	Diagonal 60°	Diagonal 90°

※ Door Camera Wiring : Polarized 4 wire(VCC[12V] / GND / AUDIO / VIDEO)

※ Recommend adaptor : CT-140200 (14V) / UT60-140210-6-02(14V)

※ Kocom is not responsible of non verified power supply.

Name and Functions of Each Part

■ Monitor part

· Front



· Up side

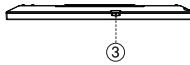

· Back

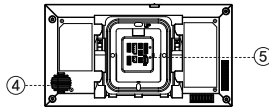

- ① 7" Touch LCD Monitor with touch screen
- ② Microphone
- ③ DC Power ON/OFF Switch
- ④ Speaker
- ⑤ Terminal : Ports for Door camera1,2, Interphone, Door open, Inner data

■ Camera part

· Front

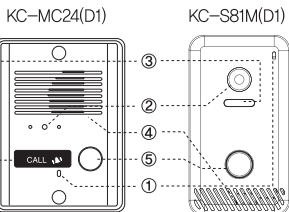
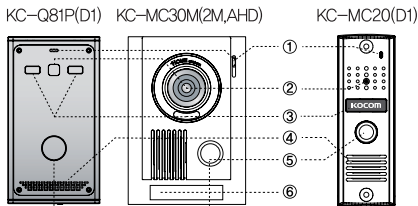

- ① C-Mic : To communicate with Monitor
- ② Camera Lens
- ③ LED
- ④ Speaker
- ⑤ Call Button : Calls resident

· Back

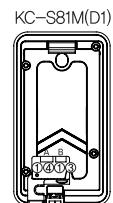
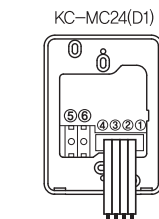
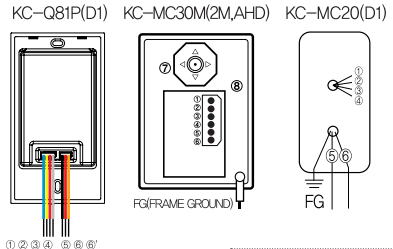

- ① VCC ⑤&⑥ Door (Non-Polarity)
- ② GND ⑦ Camera angle knob
- ③ Audio (Only KC-MC/MC30)
- ④ Video ⑧ Wire clamp

- A ① VCC(BLUE)
- ② GND(YELLOW)
- ③ AUDIO(RED)
- ④ VIDEO(WHITE)

- B ① COM(BLACK)
- ② NO(BROWN)
- ③ NO(ORANGE)

Product Wiring Diagram

■ Camera mode diagram

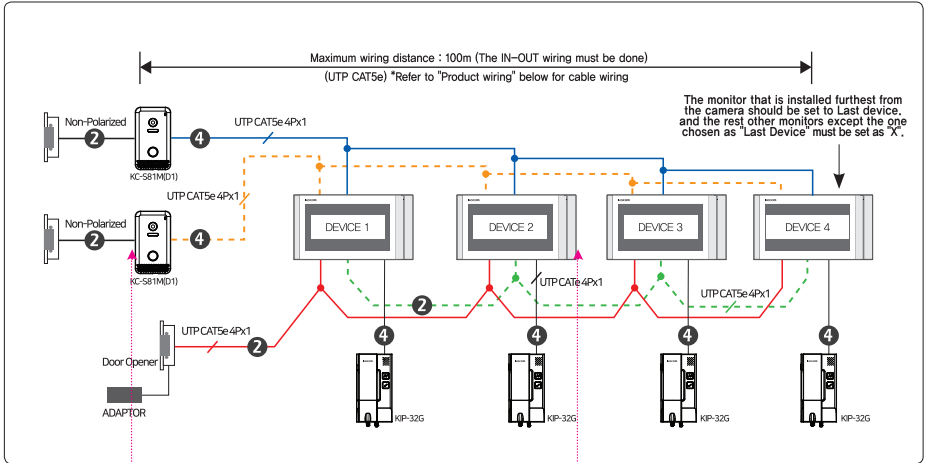

VCC(DC12V) - Orange

GND - W/Orange, W/Green, W/Brown, Brown

VOICE - Green

VIDEO - Blue, W/Blue

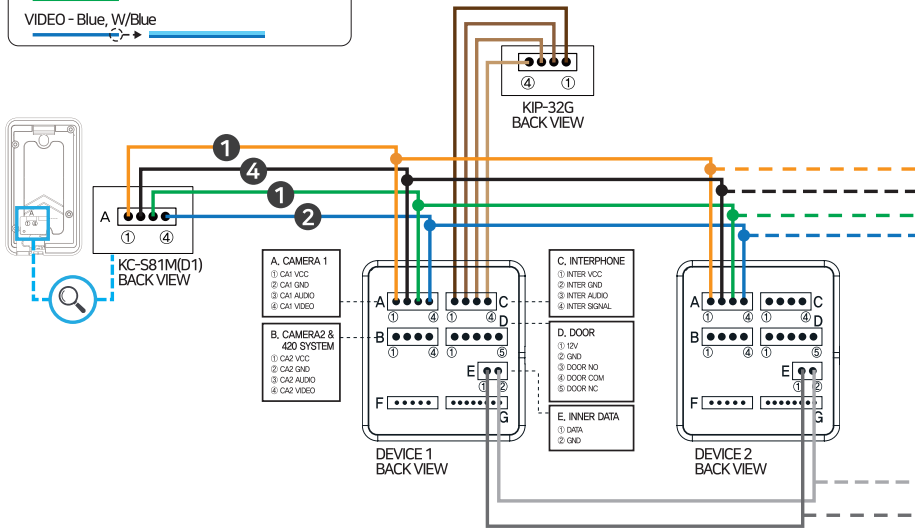

Product Wiring Diagram

■ CCTV mode diagram

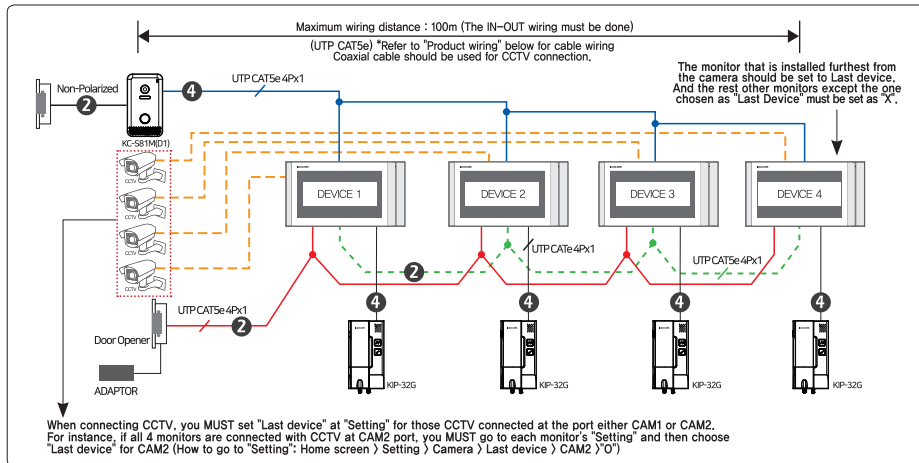

■ System mode diagram

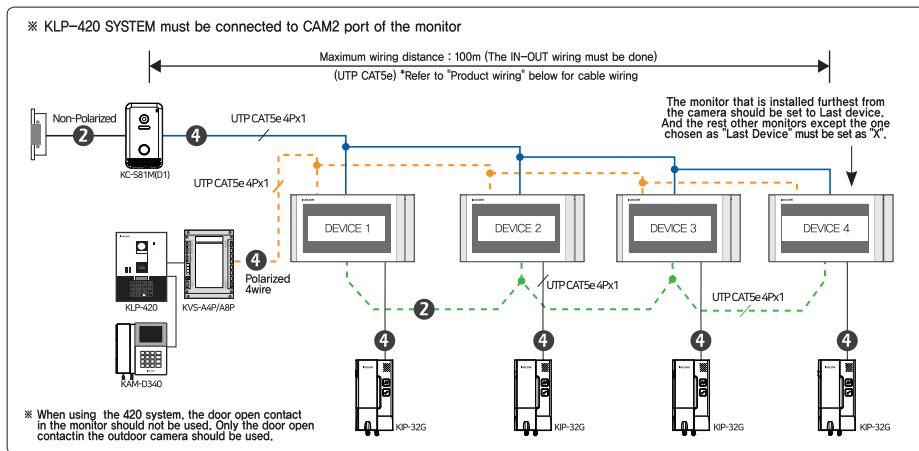

■ Terminal

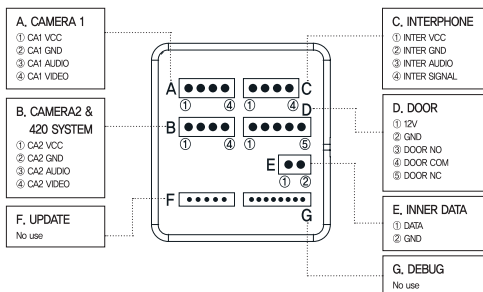

Product Wiring

■ Door camera connection (1:1)

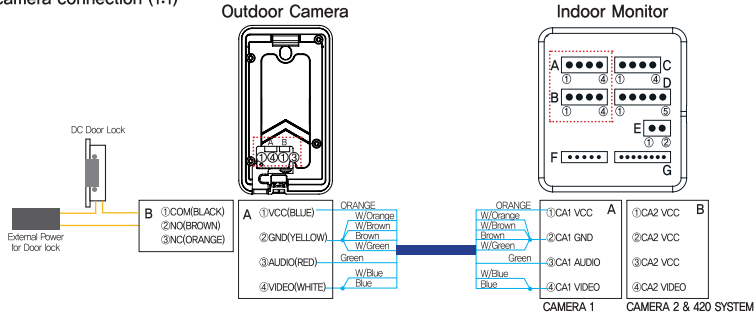

- ※ Door opener connected to the outdoor camera is available to be opened by each connected monitor separately.
- ※ Please select No or NC according to the specification of the door opener.
(You can check door opener's specification and it'll tell whether it's NO type or NC type.)

■ Monitor's Door Opener Connection

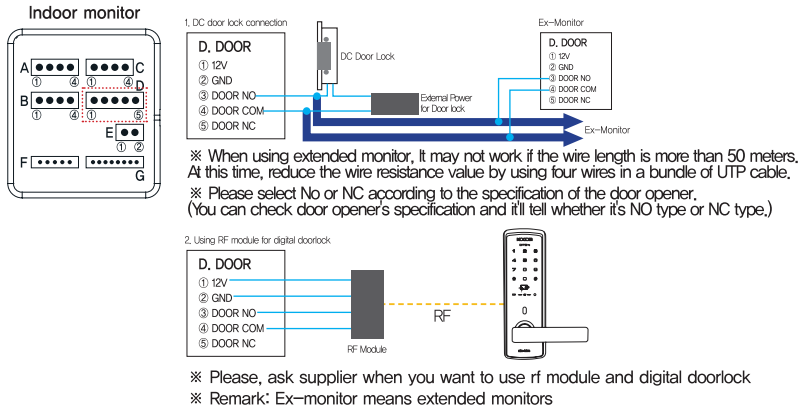

■ CAM1 – Outdoor Camera, CAM2 – Outdoor Camera Connection (Ex-monitor Connection)

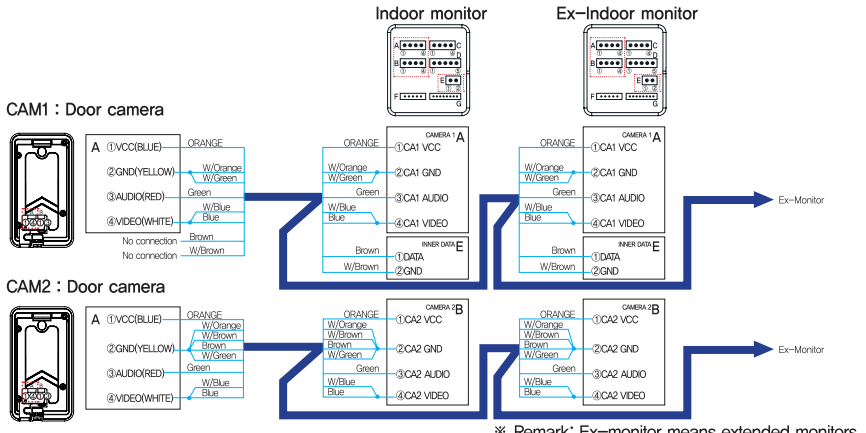

Product Wiring Diagram

■ CAM1 – Outdoor Camera, CAM2 – 420System Connection (Ex-monitor Connection)

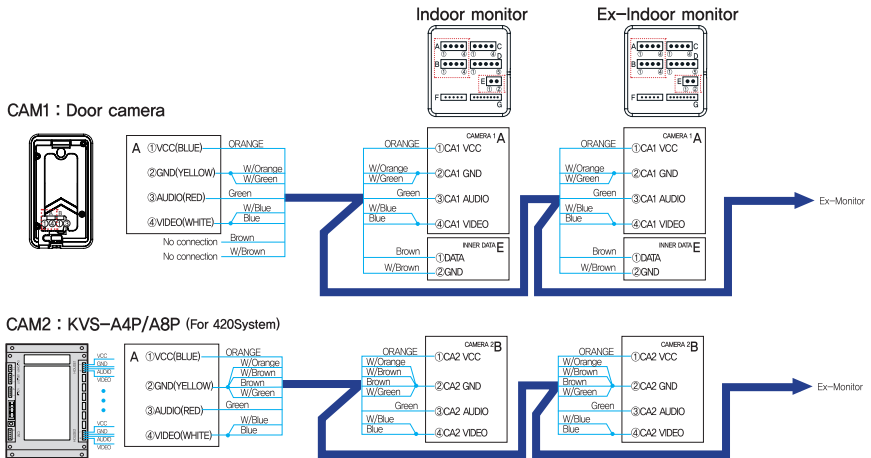

※ Remark: Ex-monitor means extended monitors

■ CAM1 – Outdoor Camera, CAM2 – CCTV Connection (Ex-monitor Connection)

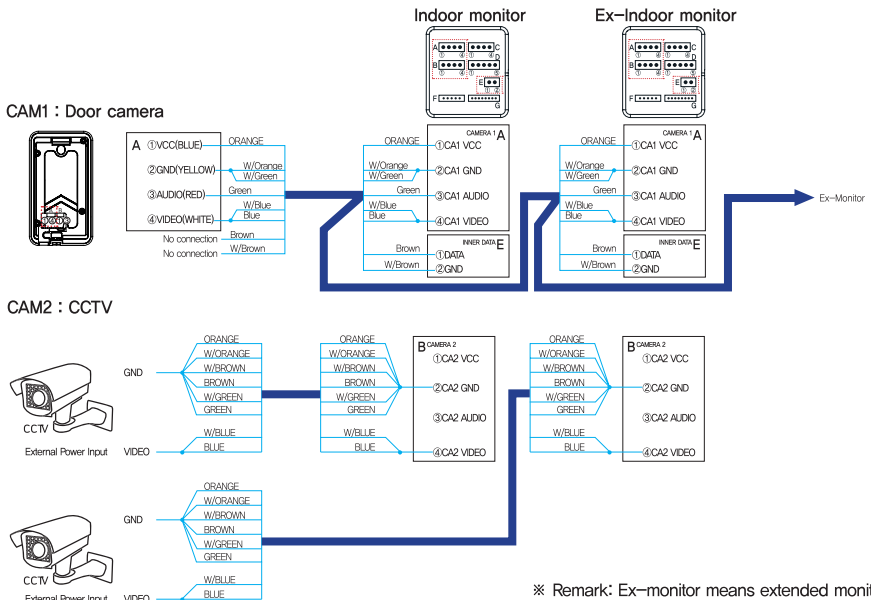

※ Remark: Ex-monitor means extended monitors

Product Wiring

Correct wiring

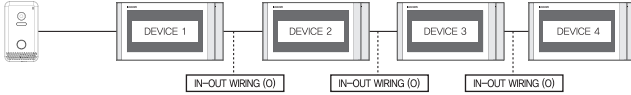

Incorrect wiring

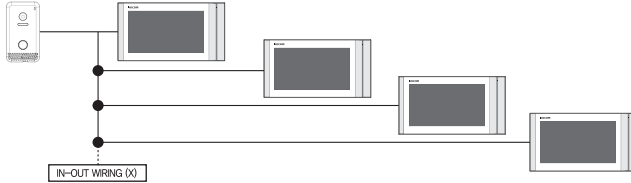

Incorrect wiring

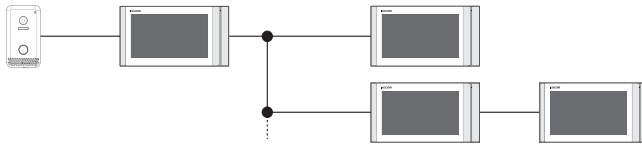

■ CCTV Camera connection (CAMERA 1,2 Port) (How to Connect when using coaxial cable)

MONITOR CA1 or CA2

- ① CA1 or 2 VCC
- ② CA1 or 2 GND
- ③ CA1 or 2 AUDIO
- ④ CA1 or 2 VIDEO

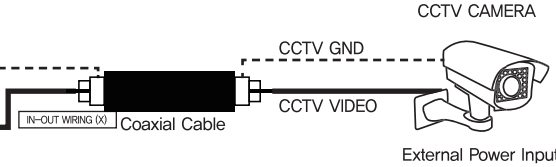

- Please obtain CCTV camera power on its own.
- Only compatible with 1080p/720p AHD (CCTV, TVI ,CVI) camera.
- Use Coaxial Cable for CCTV connection.
- Using UTP Cable might lead to lower video resolution or no video output.
- Upon initial monitoring, Video motion blur effect may occur due to automatic video recognition.

- ※ UTP CAT5e : The resistance of 100m of cable should be 10 ohms or less.
- ※ More than 50 meters of distance may cause quality failure. Recommended wire specification as follow.
 - Upto 50m : UTP CAT5e
 - Upto 100m : Coaxiable cable (RG-59)
 - (Connect core to Video & shield to GND)

■ Interphone connection (Connection for from Interphone to Indoor monitor when using 1 UTP cable)

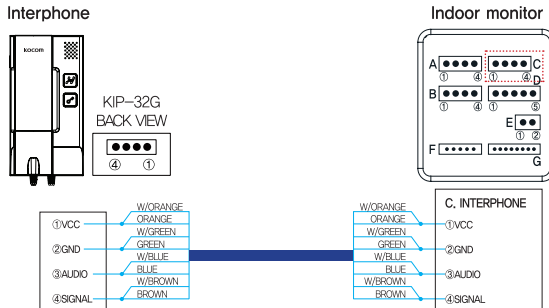

KCV-T701SM How to Operate

※ Cautions Before Using the Device

Please follow following steps before using the device.

1. DEVICE ID

- When extending additional monitors, each ID must be set, ID collision may cause malfunction.
- In case of ID Collision, "ID collision" may be shown at the top of its screen.
- How to Set: Home Screen > Setting > GENERAL > Device ID

2. Last Device

- After additional monitors extension, the last monitor far away from the outdoor camera must be set "O" at the menu "Last Device". In case of wrong setting, automatic image detection or image quality may be poor.
- How to Set: Home Screen > Setting > CAMERA > Last Device > Cam1 / Cam2 > O

3. CCTV

- When using CCTV, please select "CCTV" at the "Camera" setting.
- How to Set : Home Screen > Setting > CAMERA > Use as > CAM1/CAM2 > CCTV
- Some CCTV may have compatibility issues, so the image won't be displayed well.
- For those monitors connected CCTV, you MUST go the setting and then choose "Last device".
- How to Set : Home Screen > Setting > Camera > Last device > Cam1/Cam2 > O

4. 420System

- When using 420System, please select "420System" at the "Camera" setting.
- How to Set : Home Screen > Setting > CAMERA > Use as > CAM2 > 420System NTSC/PAL
- 420System is only available at CAM2 port (Refer to page 7)

5. Video AUTO Detection

- Depending on the condition, image at the door camera or CCTV may not be automatically detected
In this case, we recommend to use "Manual" at the below described steps.
- How to Set : Home Screen > Setting > CAMERA > Image Format > CAM1/CAM2 > Please select image format that best fits to your condition.

6. Capture Function

- When "Capture" function operates, image saving is in progress in the internal memory. In case of the device's power gets turned off, the image cannot be saved. In case of the worst situation, the stored images will be all deleted. In case of these issues, previous stored images cannot be restored.

7. Save Settings Value Feature

- When the device gets turned off while saving is in progress, all setting will be initialised.
In case you need to turn off the device, move to home screen UI and turn off after 4 secs.

Power ON

- Before turning the devices on, all connection (door cameras, extension monitors, etc) must be fully made.
- As you turn on the power switch placed at the top of its device, and you will find booting progress and the home screen afterward in order.
- When booting, system will be automatically set as soon as the outdoor camera and the extended monitors gets automatically detected.
- Booting time takes approximately 20~25 seconds.

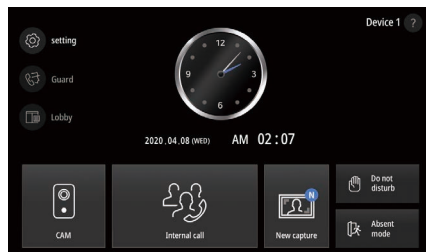
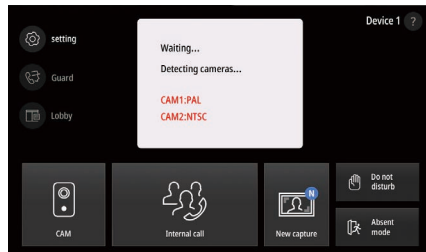
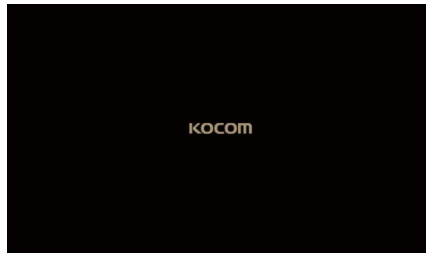

Home Screen Setting

- Home screen is the start screen where all functions of the product can be run.
- Press menu icon in Home screen to run desired functions.



Home screen UI

- ① Icon for Setting Screen :



Menu setting

- ② Icon for Calling Guard Office :



Guard call button (This is when using 420 system, For this configuration please refer to "Setting Menu")

- ③ Icon for Monitoring Lobby :



Lobby monitoring button (This is when using 420 system, For this configuration please refer to "Setting Menu")

- ④ Icon for Monitoring Front Door :



CAM monitoring button

- ⑤ Icon for Internal Call :

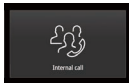

Internal call button

- ⑥ Icon for Viewing to a Saved Capture Image :



Button for viewing the screen capture images

- ⑦ Icon for Preventing Disturbances :



Button to function all of the calling melody in silence

- ⑧ Icon for Setting Up When Going Out :



Button for outgoing (This makes auto screen capture when calling from outdoor or interphone)

- ⑨ Analog Clock :



Current data and time display. Rarely time difference can be happened, so please revise with proper time at the setting

- ⑩ Icons for Device Number :



Display device number set at the Setting

- ⑪ Icons for Help :



Display QR code that connects to the manual to be shown in your mobile phone

Calling From Outdoor Camera

When calling from the outdoor camera, you can see the image of visitors, make a call, and open the door.

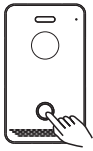

Press the call button to make a call.



When calling to the monitor, you will see visitor's image. Press call button, then calling with visitor can be functioned. After pressing door open button, door opens right away. After door opening, calling will be automatically off after 5 secs. (Calling time : 30 secs) (Door opening time : Default 2 secs, you can change at the "Settings")

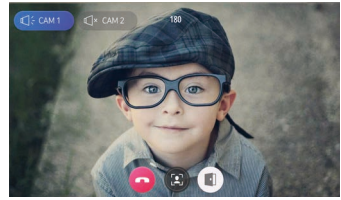

When pressing OFF button while talking with visitors, calling will be OFF. Press door open button then you can open the door. (Talking time : 180 secs) (Door opening time : Default 2 seconds, you can change at the "Settings")

※ Caution

1. In case of extended monitors and interphones, all of the devices will receive at once when calling from the outdoor camera. If one device gets connected, the rest will be automatically off.

About Call Screen Icon (UI Function Buttons)

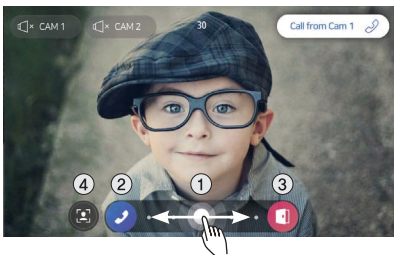

- ① Touch drag : By dragging left or right, either calling or door opening is available.
- ② Call button : Receive call.
- ③ Door open button : Door gets opened.
- ④ Capture button : Screen capture and save.

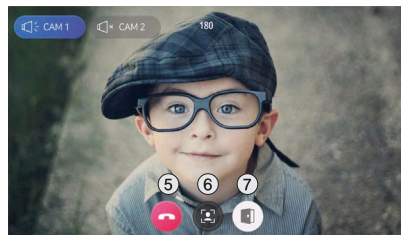

- ⑤ Off button : Finish operation.
- ⑥ Capture button : Screen capture and save.
- ⑦ Door open button : Door gets opened.

Monitoring Outdoor Camera



When pressing the outdoor camera monitoring button, the image from the outdoor CAM 1 will be shown,



While the image of outdoor camera #1 is on, press "CAM2" then you see the other image. While the image of outdoor camera #2 is on, press call button and you get connection. (Image display time: 30 secs)

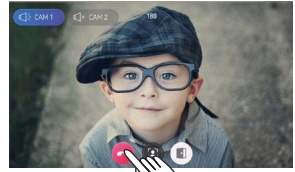

Press off button then calling gets finished. (Calling time : 180 secs)

※ Caution

1. When the other device is in use of one specific outdoor camera, monitoring function cannot be activated.
2. When CCTV is connected with the monitor's terminal for outdoor camera's, calling and door opening is not available but only image monitoring.

(※ When CCTV is connected, you MUST set "CCTV" at the "Setting". For further details please refer to the description of "Setting Screen"

Control of the Outdoor Camera's Image & Sound Volume













When pressing the button one time while the outdoor camera's image is on, image brightness control bar & voice control bar will be displayed.



You can adjust by scrolling the control bar for either brightness or melody sound volume and voice volume control. When receiving a call then beeping sound will be adjusted, and likewise calling voice while calling. By pressing image setting button, then more image color is available to be adjusted.

Control Bar Icon

-  Melody sound volume control bar : You can adjust melody speaker volumes
-  Calling voice volume control bar : You can control speaker volume when calling
-  Brightness control bar : You can adjust the brightness of the image
-  Wide view : You can see below 4 control bars in detail
-  Contrast control bar : You can adjust the image's brightness
-  Saturation control bar : You can adjust the colour's density of image
-  Hue control bar : You can adjust the hue value of image
-  Sharpness control bar : You can adjust the visibility of image
-  Closing button : You can close the following menu
-  Restore button : You can restore the setting status into default

Extension Calling & Receiving Function

In case of extended monitors or interphones, you can perform extension calling.
To perform extension calling, you MUST set each device's numbering at the "Setting"
From ID #1 to #4 is available to register, you MUST register in order.

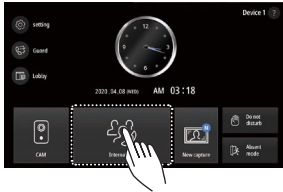

When pressing extension call button, the menu for extension call will be displayed.
Device number is automatically shown
If there's a same device number already, "ID Collision" will be shown at **Device 1**

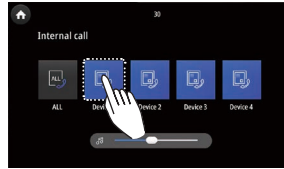

Whole devices calling or each calling is available at this stage.
When pressing a device button, that device calling will be in operation.
While calling, icon will be changed.
When pressing "Home icon" at **Home** call will be cancelled. In case of extension interphone, the chosen interphone & its extended monitor will be calling together.
When calling the interphone of own monitor that you are handling, simply press the device number of itself. When calling the whole devices, all will be rung. (Extension calling time : 30 secs)

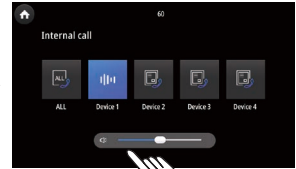

When the connection with calling device is made, calling icon will be changed into extension calling icon. By pressing home icon, calling will be off. When touching other buttons in the middle of the described function hereby, you will hear BUZZ sound to alarm you. When only one device is connected while calling the whole devices, the rest will be automatically off. (Extension talk time : 60 secs)

Receiving From The Other Monitor

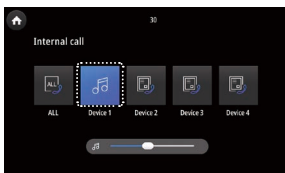

When extension calling from other monitors or interphones, extension calling melody will be rung.
Calling devices icon will be changed to music note icon. Press music note icon then calling gets connected.
When touching other buttons in the middle of the described function hereby, you will hear BUZZ sound to alarm you. (Extension calling time : 30 secs)

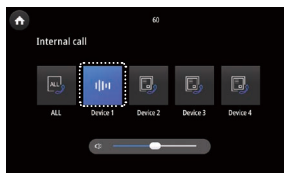

Extension calling icon is shown.
Press home button and calling will be off. When touching other buttons in the middle of the described function hereby, you will hear BUZZ sound to alarm you. (Extension talk time : 60 secs)

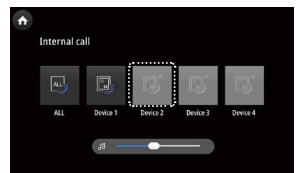

The icon when there's no device connected.

Calling From The Lobby



When calling from the lobby, calling melody will be rung. Then, the image at the lobby will be displayed. Press door opening button and lobby's door gets opened, then talk will be off right away. Press call button and you gets connection with the lobby.
(Calling time : 30 secs)

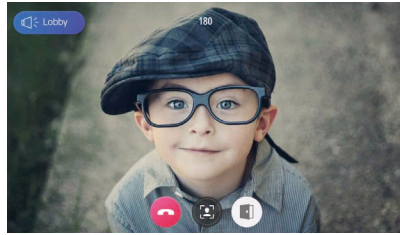

Pressing door opening button during talk status, then the lobby's door gets opened and calling will be off. Press off button and the talk will be off.
(Calling time : 180 secs)

Calling From The Guard

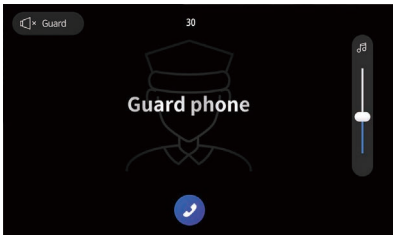

When calling from the guard, then guard calling melody will be rung. Press calling button and you get connection with the guard, (Calling wait time : 30 secs)

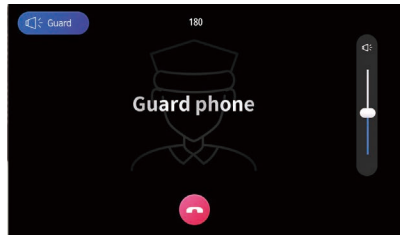

Press end button during talk status, calling will be off.
(Talk time : 180 secs)

Calling The Guard

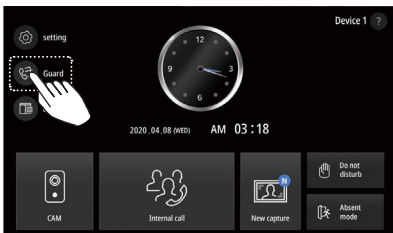

Press guard button at home screen, then guard calling will be on. When calling the guard, guard talk screen will be displayed.
(Calling time : 30 secs (Display time gets counted from 180 secs))

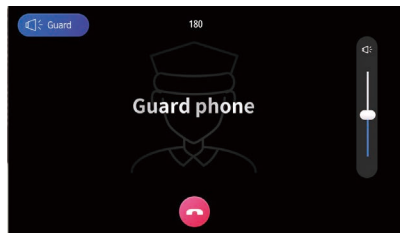

When pressing off button at this screen, calling will be cancelled. When calling from the guard, you can talk with the guard. During talk status, press off button then calling gets off.
(Max. calling time : 180 secs)

Lobby Monitoring

KLP-C420 firmware more than 03.00 ver, KVS-A8P/A4P firmware more than 03.00 ver are available



Press lobby button from the home screen, then lobby can be monitored.

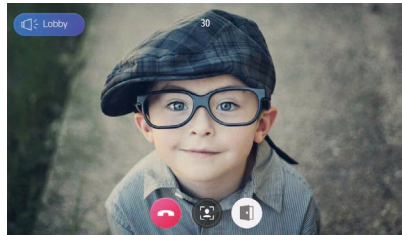

When pressing door open button during monitoring status, the lobby door's gets opened and calling gets off right away.
(Monitoring time : 30 secs)

To View Screen Captured Images

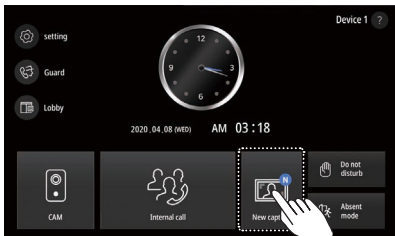

Press image view button at the home screen, then the screen for captured images lists will be displayed. 'N' icon at means the recent images are being saved. Maximum 32 images can be stored. Images will be deleted from the oldest and then recent one gets saved.

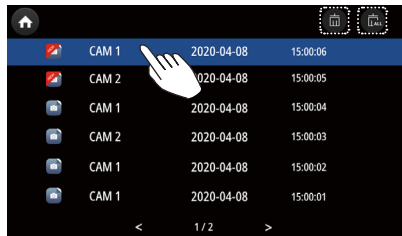

Click the image and the selected will be displayed.
Press you will delete the selected image
Press you will delete the whole listed images.
The new image will be shown as 'NEW' as



At the image view screen, you can see stored images. Press left or right arrow button, then you can see other images. Press delete button and deletion can be made right away . Press home button at and the image lists will be displayed.



Touch the middle side, then full screen gets displayed.
Press backward button at then the previous captured images list will be displayed.

QR Code

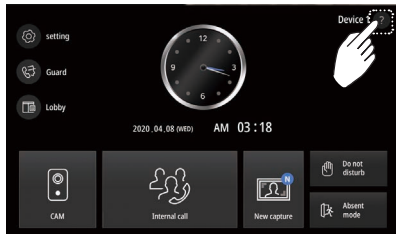

Press Help button from the home screen,
Manual QR code appears,

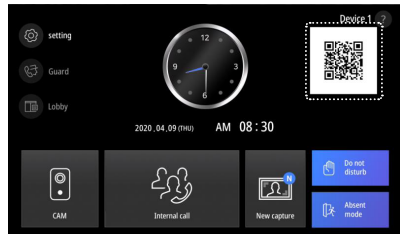

Take a QR code and check the manual.

Following Points are Normal Operating Condition, NOT a Quality Failure

- ① When connected monitor is in talk status, KIP-32G the sub interphone gets connected when you pick up the handset. (It means the sub interphone can hear and join into the communication)
- ② When calling from CAM 2 during CAM 1's calling status, CAM 1 gets automatic off and it automatically gets to CAM 2 calling status. (Vice versa likewise)
- ③ Existing calling gets cancelled and changes to the new one when in the middle of calling or monitoring are performed at CAM 1, CAM2, Lobby, Guard, Device.
- ④ Existing talk gets off and the new one calling status is shown while talking on the CAM 1, CAM 2, Lobby, Guard, Device .
- ⑤ For the farthest monitor from the outdoor, please select "O" other vidophone except the one must be set "X". (Go to the Setting →) And then set choose "O" at the "Last Device")
- ⑥ Extension talk is using CAM 1's voice line, so you MUST connect CAM 1 with all monitors in parallel.
- ⑦ Connect at CAM 2 terminal for the Lobby, Guard configuration, and choose either NTSC or PAL as follows. (Setting→)Camera: Use as Cam2 420system)
- ⑧ To call the guard from the monitor, the screen for guard phone talk gets displayed. Countdown from 180 secs will be on. (When the guard doesn't receive call within 30 secs, calling will be ended)
- ⑨ While lobby monitoring from the monitor, lobby image displaying and calling connection is not feasible for those KLP-C420's firmware lower than 03,00 ver, KVS-A8P/A4P firmware lower than 03,00 ver cannot function lobbyphone.
- ⑩ On the other hand, those KLP-C420's firmware 03,00 ver, KVS-A8P/A4P's firmware 03,00 are available. (30 secs) ("Direct Mode" option is available with lobby monitoring. For details please refer to the operation manual for KLP-C420)

Setting Menu Screen

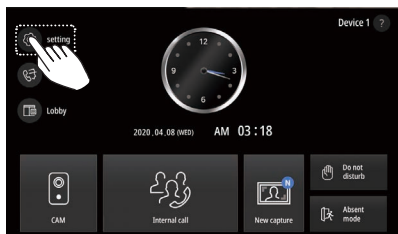

Home screen) By pressing setting button, it will move to setting menu screen,

① General

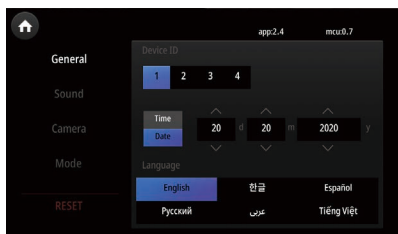

Device ID : Setting monitor's ID.
Time Setting : System time setting.
Date Setting : System date setting.
Language : System language setting.

② Sound

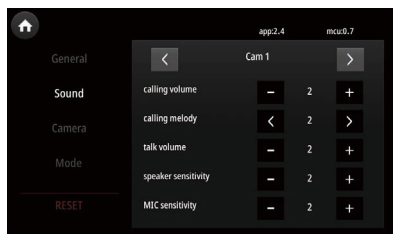

Sound item : Cam1, Cam2, Lobby, Guard, Device, Interphone
Calling volume : 1~9
Calling melody : 1~6
Talk volume : 1~3
Speaker sensitivity : 1~2 (Highly recommend to use in default)
MIC sensitivity : 1~2 (Highly recommend to use in default)

③ Camera

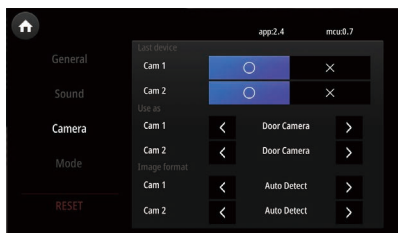

Last device (If the device is far away from the outdoor camera, then select "O") and the rest other monitors except the one chosen as "Last device" must be set as "X". If using CCTV, then select "O".

Use as

: Door Camera, CCTV, 420system NTSC(Lobby NTSC image, for Guard function),
 420system PAL(Lobby PAL image, for Guard function)

Image format

: Auto Detect (Image Signal Automatic Detection)

: Door camera image format (NTSC / PAL / AHD 1080p/25 / AHD 1080p/30)

: Manual NTSC (In case of wrong selection in manual detection, black colour background or abnormal image will be displayed from the LCD screen.)

: Manual PAL (We recommend to use manual detection as automatic detection may malfunction depending on the conditions)

CCTV Image format

: Manual AHD 720P/30 : Manual TVI 720P/30 : Manual CVI 720P/30

: Manual AHD 720P/25 : Manual TVI 720P/25 : Manual CVI 720P/25

: Manual AHD 1080P/30 : Manual TVI 1080P/30 : Manual CVI 1080P/30

: Manual AHD 1080P/25 : Manual TVI 1080P/25 : Manual CVI 1080P/25

④ Mode

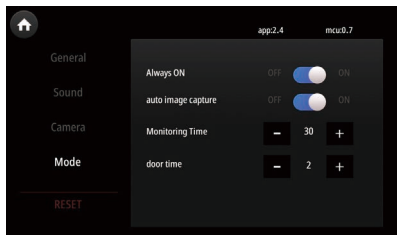

Always on

: (User mode: OFF) LCD's afterimage will be happen when you select "ON"

Auto capture

: When you select "ON", automatic screen capture available as per visitor's call.

Monitoring time

: You can select 30 sec, 60 sec, 120 sec, or 180 sec (The time monitoring lobby is fixed for 30 seconds)

door time

: Door open time is during 0.2sec, 1~9sec

⑤ Reset

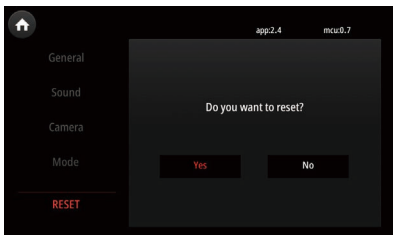

When you select "YES", then factory mode will be activated. (Except selected language)

Warranty

- To receive after service, have the following ready before you contact our branches.

1. Name of the product.
2. Model number of the product.
3. The area of problem.
4. Phone number and address at which you can be contacted.

Warranty Card

PRODUCT	
MODEL	KCV-T701SM
DATE PURCHASED	
WARRANTY PERIOD	
AGENCY ADDRESS	

- KOCOM Warranties the original purchaser of this product as follows.

- 1) This product is produced under strict quality control and inspection procedures.
- 2) If this product breaks down during proper use as a result of product defect, KOCOM will repair it within one year from date of purchase free of charge.
- 3) The following cases will be subject to charge, even during warranty period:
 - a. Breakdown during transport, or through careless treatment, by consumer.
 - b. Breakdown cause by unauthorized repair, or system modification.
 - c. Breakdown caused by natural disaster or power disorder.

- Note: This equipment has been tested and found to comply with the limits for a Class B digital device, pursuant to part 15 of the FCC Rules. These limits are designed to provide reasonable protection against harmful interference in a residential installation. This equipment generates, uses and can radiate radio frequency energy and, if not installed and used in accordance with the instructions, may cause harmful interference to radio communications. However, there is no guarantee that interference will not occur in a particular installation. If this equipment does cause harmful interference to radio or television reception, which can be determined by turning the equipment off and on, the user is encouraged to try to correct the interference by one or more of the following measures:

- Reorient or relocate the receiving antenna.
- Increase the separation between the equipment and receiver.
- Connect the equipment into an outlet on a circuit different from that to which the receiver is connected.
- Consult the dealer or an experienced radio/TV technician for help.



www.kocom.com

E-mail : export@kocom.com

This manual is based on the date as shown in the right and specifications are subject to change without notice for quality improvement

KCV-T701SM

U0506