

thefirebeamTM protectionsystemplus

user guide



issue 0025-08

thefirebeam™

Reflective optical beam smoke detector **user guide**

1 Distance and position guidelines

These guidelines are recommendations only and it is important that you refer to your appropriate governing standards at all times.

When positioning your firebeam there are important factors that you should consider, mainly what distance you are covering and the optimal position in the building.

What distance?

The standard firebeam is suitable for distances of **5m to 40m** to the reflector. If you require **40m to 80m** you will need to use the **mid range reflector extension kit**. For ranges of **80m to 100m** you will require the **long range reflector extension kit**.

5 to 40 metres the standard firebeam

The standard firebeam comes boxed with the head unit, low level controller, one reflector, 3mm allen key and quick start installation guide, this should be used for distances over 5m and up to 40m.

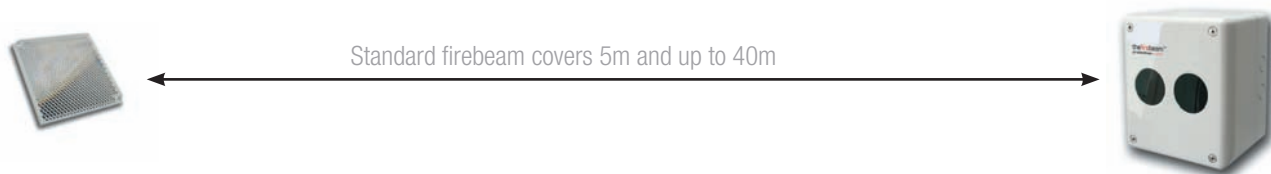

40 to 80 metres - the standard firebeam + mid range 40 to 80m kit

For distances of 40 to 80 metres you will need to use the standard firebeam and a **mid range extension kit** (the mid range kit comes with a backing plate and 3 extra reflectors, you will need to add the reflector from the standard kit to the mid range kit with the screws provided).

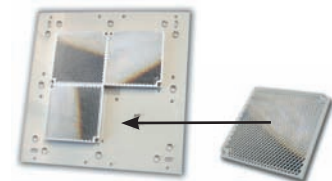

80 to 100 metres - the standard firebeam + long range 80 to 100m kit

For distances of 80 to 100 metres you will need to use the standard firebeam and a **long range extension kit** (the long range kit comes with a backing plate and 8 extra reflectors, you will need to add the reflector from the standard kit to the long range kit with the screws provided).

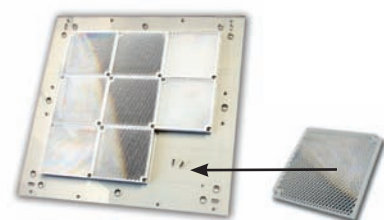

What position?

A roof is considered flat unless the height of the apex is greater than 0.6m. If the roof is flat the firebeam system can be placed anywhere under the roof between 0.3m and 0.6m below the roof, up to a maximum height of 40m from the floor. The firebeam has a detection area of 7.5m either side of the beam. If the roof is considered to have an apex, place the firebeam system 0.3m to 0.6m down from the top of the apex, up to a maximum height of 40m from the floor. The maximum protected area either side of the beam can be extended by 1% for every degree of roof pitch, see the example below:

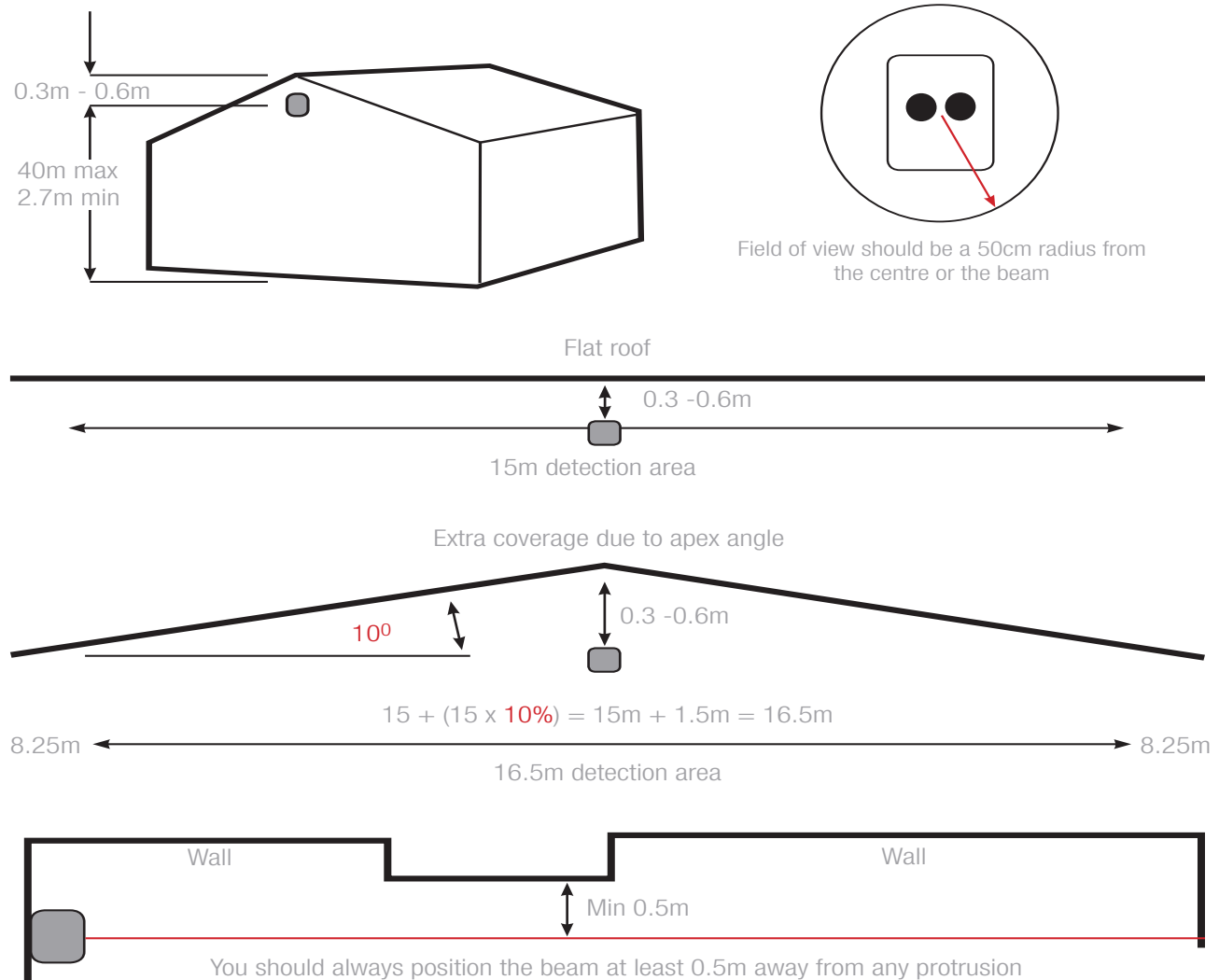

Note. Careful design consideration should be made when positioning beams and reflectors in environments that can be susceptible to condensation i.e. warehouses near to water that have areas open to the outside environment or that are exposed to quick extreme changes in temperature. To assist with this problem that can affect all beam detectors we produce an **anti-fog kit** comprising of a specially coated reflector and lens cover. Individual reflectors are also available. The standard firebeam and range kits can be supplied as anti-fog sets as a special order.

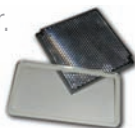

2 Installing, commissioning and testing

step 1 mounting the head

Screw the head backing plate to the wall - always try to use as sturdy a location as possible, such as brick or major structural steels (avoid mounting to outer metal cladding etc). Avoid mounting the head where direct sunlight can shine directly into the 'eyes' of the beam (care should be taken when mounting in glass atriums). Ambient sunlight will not affect the beam.

Also available - unistrut adapter plate

Use this accessory for easy mounting to unistrut fabrication. Holes are pre-drilled to the correct pitch of the head and conveniently positioned for use with unistrut.

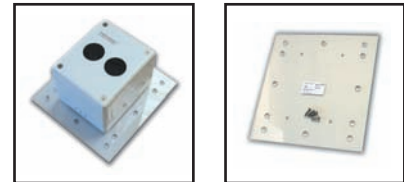

2 knock-outs are provided on both sides. **Take care when using drills not to damage the circuit board.**

Wire to low level controller using bottom colour coded terminals.

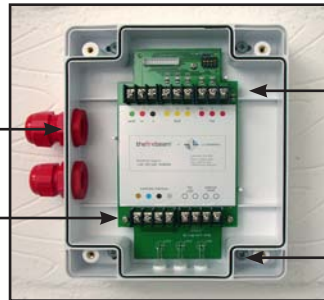

Wire into system as required (see generic wiring diagram on the following page). **Ensure that all wiring is below the level of the front edge of the box.**

Screw in through holes provided outside of the rubber seal.

Connect the head to the base plate by first plugging in the connector. **Do not** force in, white wires should be uppermost. **Should you forget to connect this the controller screen will read ERROR.**

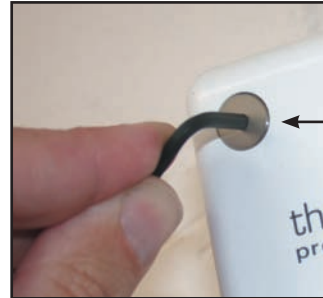

Screw the head screws down with the 3mm allen key provided. **Your wiring should be flush and not flattened by tightening down screws.**

step 2 mounting the controller

Important mount the controller at eye level and ensure easy access.



Screw in through holes provided outside of the rubber seal.

Wire to head using colour coded terminals. If this connection is not made **ERROR** will appear on the controller, this connection can be checked by reading the resistance across the black and grey terminals, they will read 110 ohm if OK or 220 ohm if not connected properly.

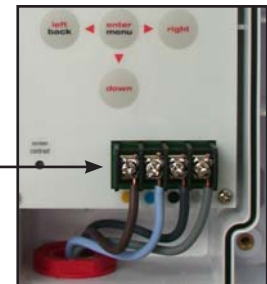

Generic wiring configurations

the**fire**beam is a conventional device, below are suggested wiring configurations for single and multi heads on a zone. the**fire**beam can easily be made addressable with the use of a manufacturers interface and in some cases can also be powered from the loop, ie with the Apollo XP95 switch monitor with isolator. Most wiring diagrams can be found on our website in more detail and in PDF format, go to [www.the**fire**beam.com](http://www.thefirebeam.com)

- Brown + supply (10.2 - 30Vdc)
- Blue - supply (return)
- Black zone +
- Grey zone -
- Green earth (screen)

Supply voltage 12Vdc to 24Vdc + 25% -15%
 Quiescent current 3.5mA
 Alarm current 3.5mA
 Aligning current Normal 3.5mA Fast 17mA
 Fault/Alarm relay contact rating 2A @ 30Vdc

FIRE and EOL components as supplied by the panel manufacturer

Single head on zone

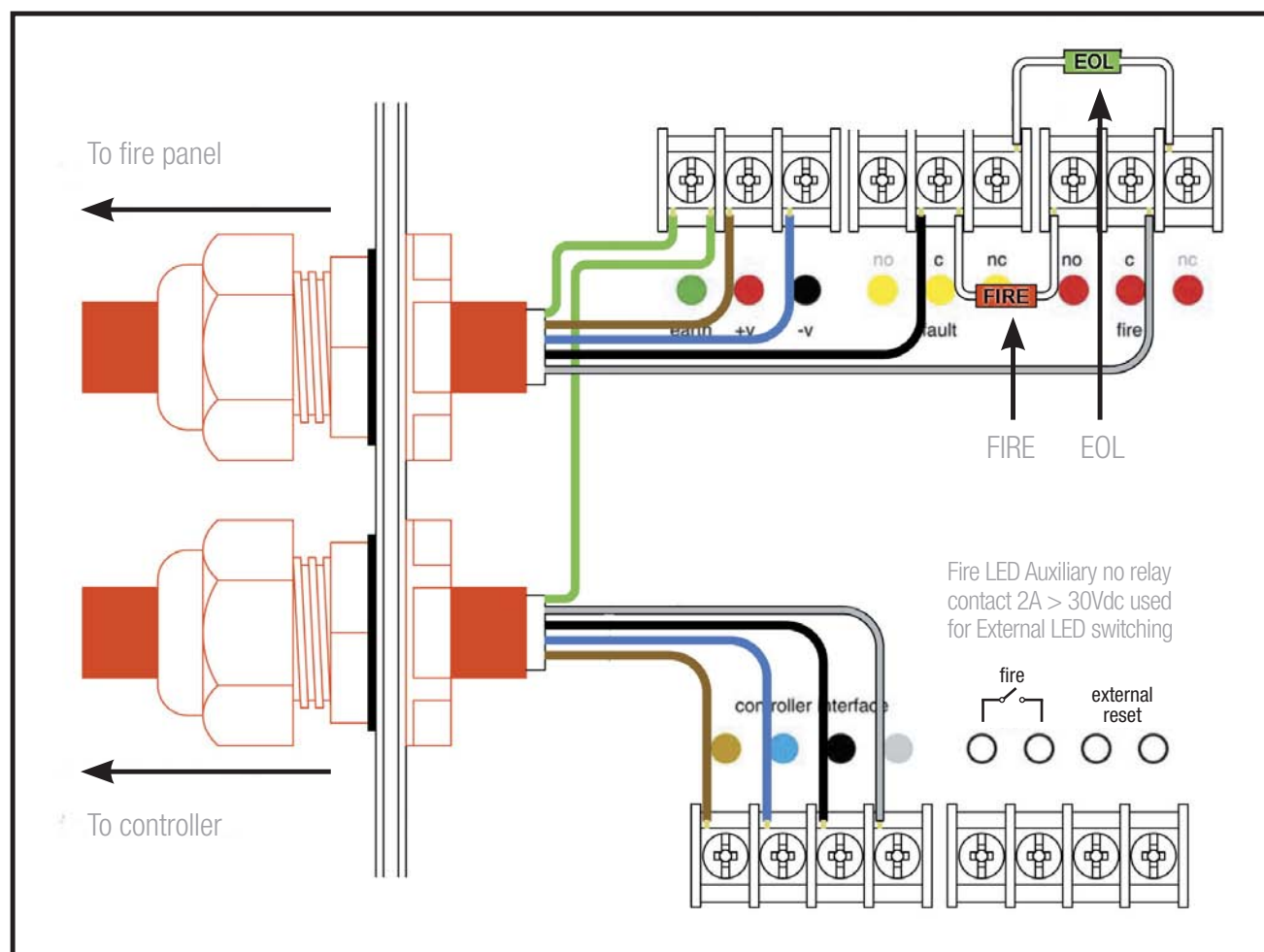

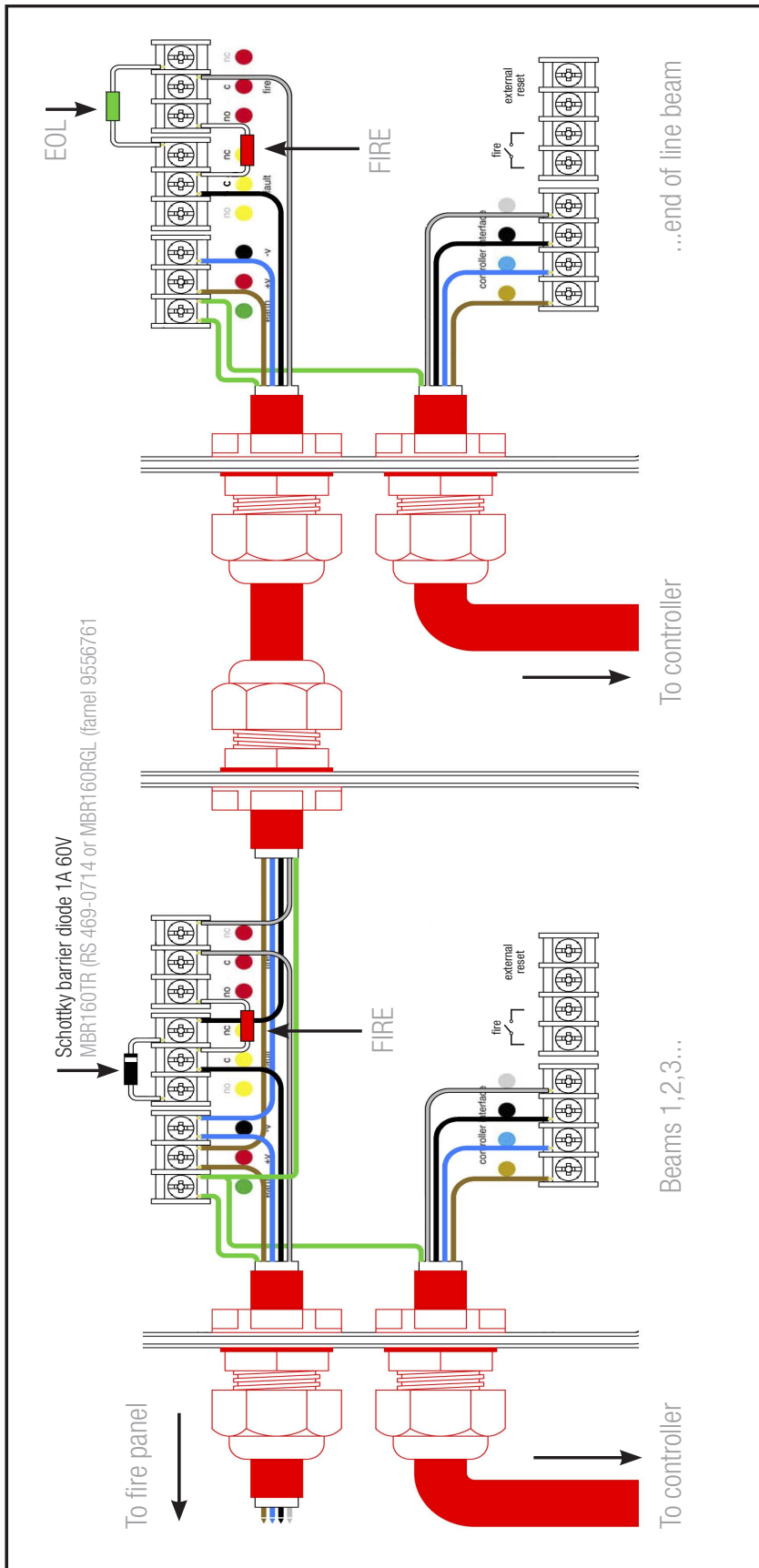

Multiple beams on a zone

Other wiring diagrams

See our website for further diagrams including interfacing with manufacturers protocols
www.thefirebeam.com

step 3 commissioning

Commissioning the firebeam is a simple procedure outlined in the following step by step explanation.

stage one, language and commissioning speed

1. **Important.** Do **NOT** put the reflector up or **COVER** it if already in place.



2. Power up the unit and you will see

thefirebeam PLUS
ver 1.01

 the screen will default to

Air Quality	0%
Status	Fault

 or

3. Access the menu by pressing **enter** 

Air Quality	0%
Status	Fire

4. The first screen you see is

english

 if you need to change this use the **right** and **left** hand keys to scroll through languages, when you have found your language press **enter** or if you are happy with English press the **down** key to continue. If you have changed the language the system will continue in your chosen language.

5. Press **enter** and you will now see the **commissioning speed** screen. In most cases it is recommended to use **fast** mode (in normal mode the system uses 3.5mA, in fast mode it uses 17mA) - if you are commissioning more than one beam at a time and the system cannot support the extra draw it may be necessary to use normal mode to prevent excessive current draw. Fast mode allows x4 times faster motor response and it may be quicker to commission each beam in turn. Once commissioning is complete the firebeam will automatically revert to normal low power mode - (3.5mA).

6. Use the **left** and **right** keys to toggle between fast and normal, the ***** indicates which mode is selected. Press the **enter** key to continue.

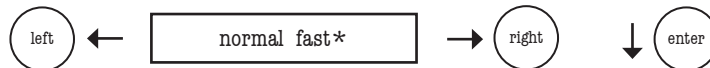

stage two, pre-alignment

7. The next screen is

pre-alignment

 this is probably the most important part of setting up your beam. Pre-alignment sets up the amount of power you need for the distance you are covering and can indicate if you are receiving unwanted reflections from anything else in the beam path.

8. Press **enter** to begin **pre-alignment**. Remember **no reflector**. You will see the screen below. Take a moment to understand what the figures on the screen mean.

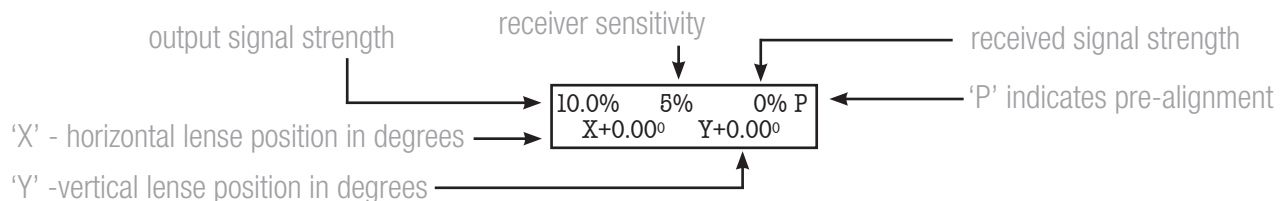

Receiver sensitivity starts off at 5% and output power starts at 10%. The beam will start by raising its sensitivity first and can rise all the way up to 100%, after this the output power will rise. The objective of pre-alignment is to adjust the output power to the correct levels for the distance to be covered. As there is no reflector we are looking for a reflection off the far wall. Power levels will rise until they reach a maximum of anything up to 6 to 7% of received signal strength (nb. figures may fluctuate between these values), once this is achieved the power level will automatically stop rising any further.

By looking at the table below you need to judge if you are receiving enough power to cover the required distance.

5m.....5%	30m.....20%	60m.....40%	90m.....65%
10m.....10%	40m.....25%	70m.....50%	100m....75%
20m.....15%	50m.....30%	80m.....60%	

Note: Anything more than these levels is good and continue down to **9**. If you are receiving noticeably less read on below.

These figures are **approximate** but if you are receiving **noticeably less** than these figures you may be receiving a reflection from an object nearby and not the far wall. By moving the beam (looking at the far wall) left (x-) right (x+) up (y+) and down (y-) you can move the beam path away from the obstacle. By doing this you will be able to achieve a suitable output power. In extreme cases it may be necessary to physically move the beam head to obtain a clear line of sight.

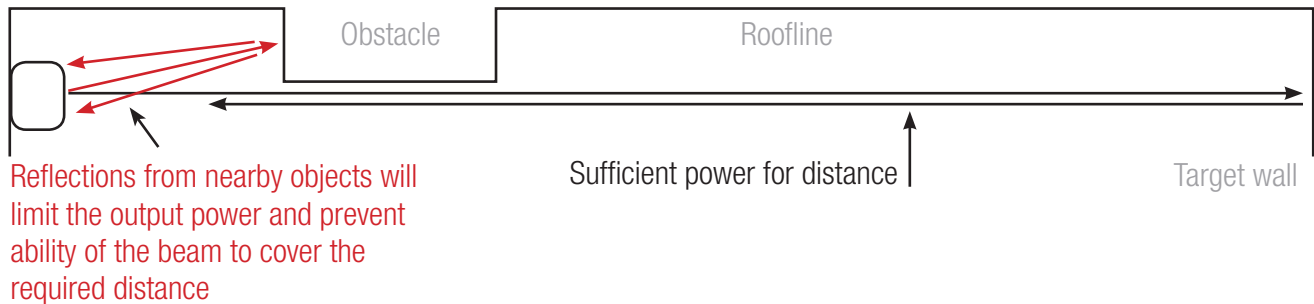

9. Once you are happy with your power readings **press enter to accept pre-alignment** and confirm these settings by pressing the **right key**.

Note: It may be that no reflection is received and power and sensitivity levels rise to their maximum, if this is the case pre-alignment will automatically register **Pre-Align - Complete**. Confirm these settings by pressing the **right key**.

10.0% 100% 6% P X+0.00° Y+0.00°	enter	Press → (right) to confirm	right	Manual Alignment	enter	Manual AQ 6% X+0.00° Y+0.00°
OR If no reflection is seen you will see this screen.						
Pre-Align - Complete Press → (right)	right	Manual Alignment	enter	Manual AQ 6% X+0.00° Y+0.00°		

stage three, manual alignment

You will now see the manual alignment screen showing anything between 0 and 6%. This is the amount of received signal with no reflector that the beam is picking up from the environment.

10. NOW place or uncover the reflector on the blank wall directly opposite the beam head ensuring there is a clear path through any obstructions such as structural steels etc.

It is **important** that there is a clear line of sight between the reflector and beam head. The beam must see at least **200mm** of clear space around the reflector to enable the beam to see the edges of the reflector to allow successful auto alignment in the following stage.

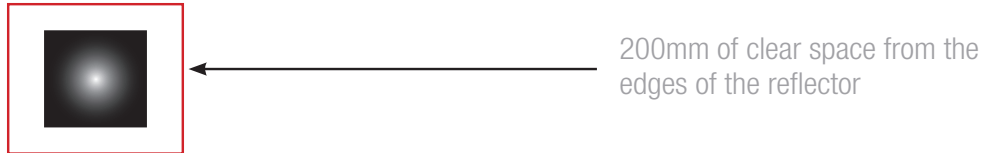

Once the reflector is in place and visible there should be a big jump in the received signal (AQ). This means that the head is seeing and receiving a signal back from the reflector. In most cases this will result in a received signal of over 100%.

Manual	AQ	136%
X+0.00°	Y+0.00°	



Manual	AQ	13%
X+0.00°	Y+0.00°	



As long as there is a received signal of over 40% you can move onto the next stage: Auto Alignment, No.11.

If the AQ reading is **below 40%** it means the head is not seeing the reflector and will abort Auto Alignment. The next stage is to manually move the beam to achieve an AQ reading of over 40%, ideally over 100%. The higher the AQ the quicker it will auto align. This is done by manually moving the x and y motors to obtain a received signal from the reflector.

In the example below we can see that the reflector is below the eye line of the beam head, so in this case you would need to lower the angle of the beam (-Y) until you receive an AQ of over 40%.

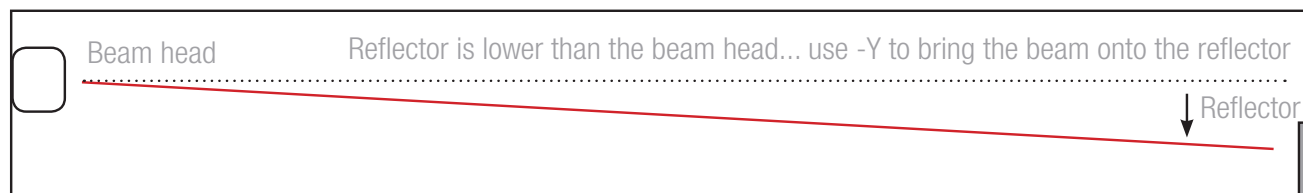

The beam can be moved on both X and Y axis to a maximum 5 degrees using the **left (x-), right (x+), up (y+) and down (y-)** keys. Looking at the reflector this will move the beam across the reflector like so...

Holding the keys down will quickly scroll through to your desired position, on release of the button the screen will revert to the actual beam position and can be seen stepping toward the requested position.

To confirm the beam is seeing the reflector **covering** the reflector at any time should drop the AQ and prove the beam is on the reflector.

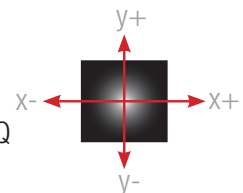

In the example above moving the y axis down (y-) results in a greater AQ

Try and achieve as high an AQ as possible, it must be over 40% to auto align. The higher the AQ the quicker the auto align, above 100% is good

Manual	AQ	6%
X+0.00°	Y+0.00°	



Manual	AQ	110%
X+0.00°	Y-2.26°	



stage four, auto-alignment

11. Having received an AQ reading of over 40% in manual mode press **enter** to exit manual and **enter** again to go into **auto alignment** mode.



First you will see the sensitivity and power readings drop if the received signal is over 100%. Once at 100% or if the reading is under 100% the **fire** beam will automatically move its y and x axis until it centres itself onto the middle of the reflector. It does this by seeing highs and lows as it falls on and off the reflector (seeing the edges of the reflector) once it has found all the edges it will then calculate and move to the centre of the reflector.

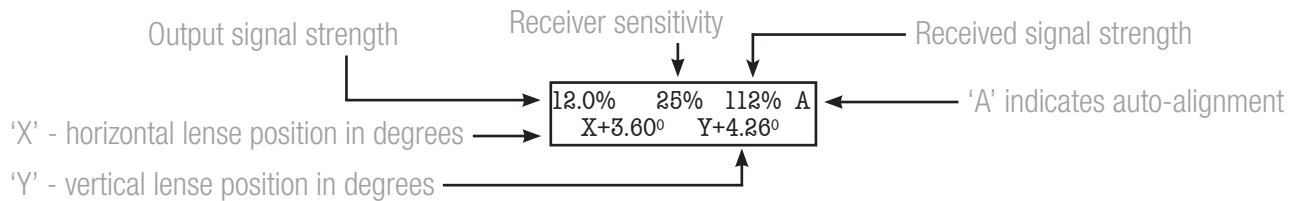

Auto alignment in 'fast' mode will take, on average, 3 minutes and in normal mode up to 30 minutes the better the beam is aligned before auto alignment (high AQ readings) the shorter the align time. Once finished **Align Complete** will appear on the screen, simply press **left back** to OK and exit.

You will now see this screen AQ may fluctuate a couple of % above and below 100%

Air Quality 100%
Status - NORMAL

Now proceed to step 4 - testing - the final stage of commissioning.

step 4 testing

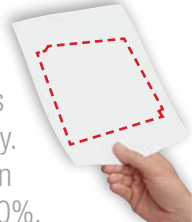
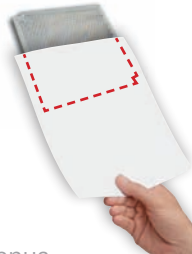
- 1. Fault test** This is done to confirm that the returned signal is from the reflector. **Cover the entire reflector within one second.** If the beam is correctly targeted onto the reflector the AQ will drop to 0% (max 10%) and will fall into a 'fault' condition (after 10 seconds). Amber LEDs will flash on both the controller and the beam head, the word FAULT will appear on the display. If the AQ is still above 10% reflections are also being returned from something else other than the reflector. This should be rectified and a fault test performed again until AQ drops below 10%. 
- 2. Fire test** Having completed the fault test the fire test confirms the functionality of the beam. Having just covered the reflector completely for the fault test now let the beam recover to its normal state and then **cover half the reflector**, in effect restricting the returned signal to 50%, the beam should then fall into a 'fire' condition (after 10 seconds). 

Once you have successfully completed both tests your firebeam is commissioned.

You can now fine tune your beam to suit the environment if needed. Look through the following menus to see adjustments that can be made.

3 Screen and menu systems

Home screen

Air Quality 100%
Status - NORMAL

This is the screen you would normally see when the beam is commissioned.

Other screens you may see are:

FIRE Air Quality 29%
Status - FIRE

The air quality level has fallen below the fire threshold setting.

If alarm is set to latching and you need to reset from fire press **enter**  to see this screen:

Alarm Reset

and press **enter**  again to reset and return to the normal screen.

This can also be reset by dropping the power to the beam for 5 seconds. If set to auto reset it will reset to normal automatically.

FAULT Air Quality 0%
Status - FAULT

The beam path has been fully blocked within 1 second (used when fault testing in commissioning).

ERROR Air Quality XX
Status - ERROR

No communication with the controller. This could be that the flying lead is not connected, or that the head is not connected to the controller, this can be checked by reading the resistance across the black and grey terminals, if connected it should read 110ohms if not connected at one end this will read 220ohms.

ALIGN Air Quality 89%
Status - ALIGN

This screen will appear when the beam is performing a self alignment, normally because of building movement.

DIRT COMP Status - Dirt Comp

This is due to the compensation for dirt build up reaching its maximum - **FAULT** or **FIRE LED** may be flashing.

How to use the menu system

Press **enter**  to go into the menu system, then press **down**  to go through the main menu options:

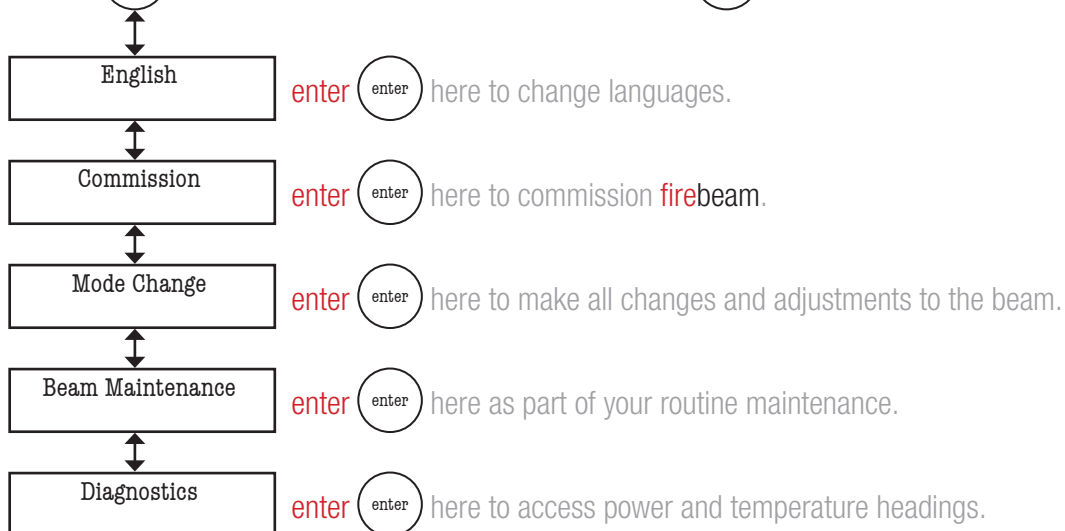

Individual menu items

1.

Language

 The **language** is factory set to English if this is okay press **enter**  to continue to commissioning or arrow **up** to return to the home screen. To change the language use the **right** and **left** keys to change to your preferred language and press **enter** to confirm your choice – you will then continue in the language of your choice. Languages currently available are: English, Dutch, Italian, French, Spanish, Czechoslovakian and German.

2.

Commissioning

 Press **enter**  to go into **commissioning**.

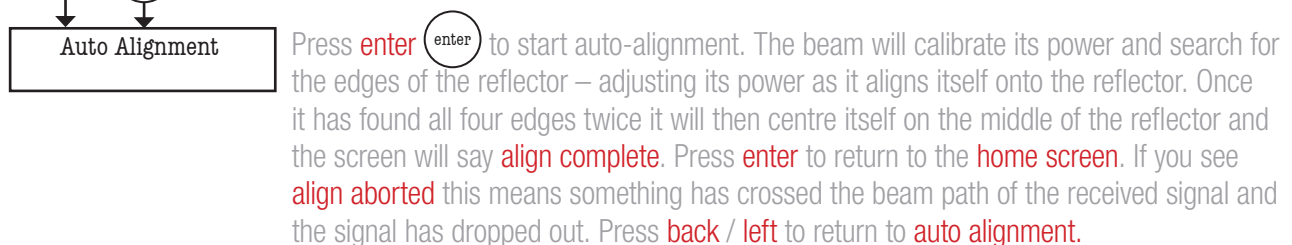
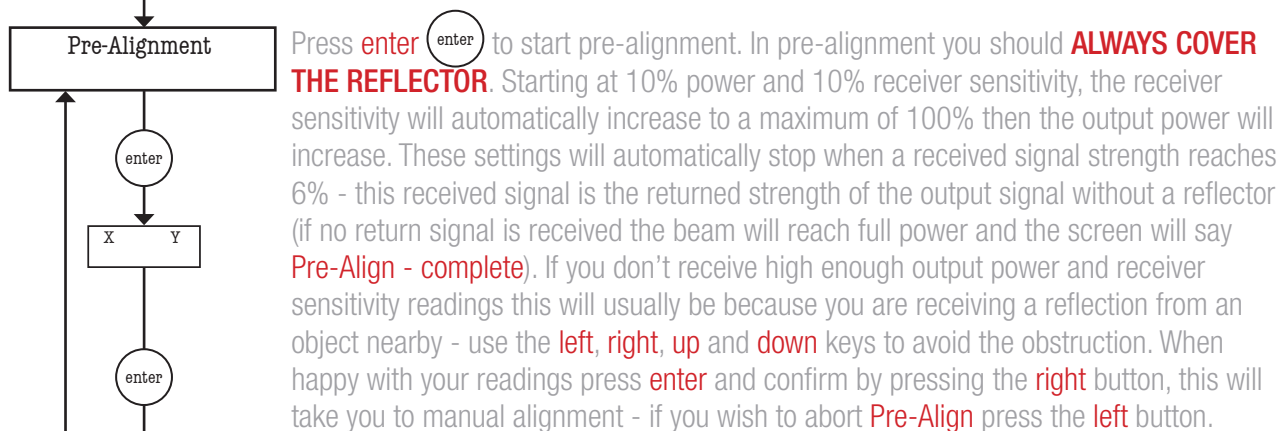
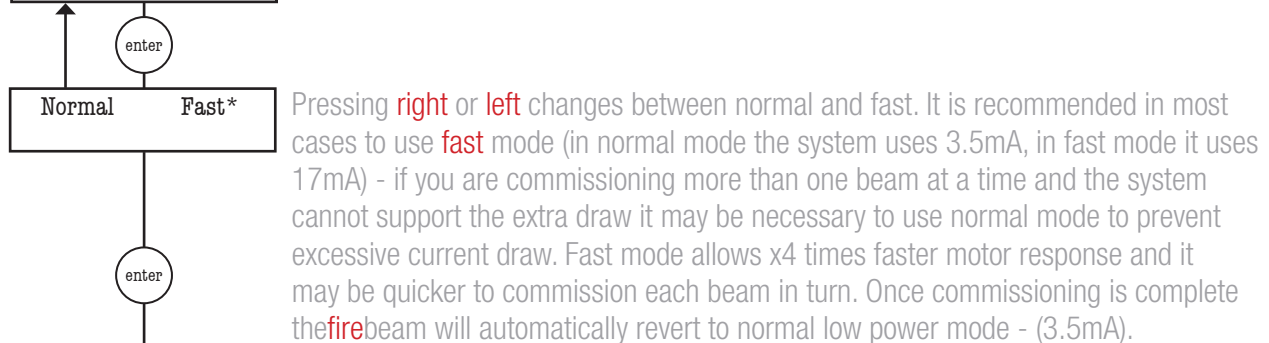

3.

Mode Change

Here we can make changes to how the beam behaves. Press **enter**  to go into **mode change** and the sub menus.

enter

Threshold

Threshold. Use the **right** and **left** keys to increase or decrease the beams sensitivity. It is factory set at 35% (meaning the received signal has to drop by 35% to trigger the fire relay. This sensitivity can be adjusted between **25% (sensitive)** and **50% (less sensitive)** (press **enter** to return to **mode change** or **down** to go to **time to fire**).

Time to fire

Time to fire. Here we can adjust how long the beam has to be in fire before the fire relay is triggered. This is factory set at 10s, you may want to increase this if there is something that may momentarily obscure the beam path (birds / forklift truck) this can be adjusted between **2** and **30 seconds** by using the **right** and **left** keys (press **enter** to return to **mode change** or **down** to go to **time to fault**).

Time to fault

Time to fault. Here we can adjust the time to fault between **2** and **60 seconds** (factory set at **10 seconds**). For a beam to go into fault the beam path must be totally blocked within **ONE** second. By using the **right** and **left** keys (press **enter** to return to **mode change** or **down** to go to **auto reset**).

Auto reset

Auto reset. The beam is factory set to **auto reset** when the received signal raises above the fire threshold **hysteresis**. This can be set to latching if your system requires this. Change by using the **right** and **left** keys (press **enter** to return to **mode change** or **down** to go to **align on / off**).

Align On/Off

Align on / off. You may want to turn the auto alignment function off, for example, in an environment that often gets filled with welding smoke, the auto align function kicks in when the received signal drops below **90%**, the point that the beam automatically checks for building movement. The beam will try to align through the smoke which could be a problem if it is unable to see the edges of the reflector. Use the **right** and **left** keys to turn off and on. When turning this function off extra care should be taken to ensure that the beam head is on a sturdy fixing ie., brick wall or major structural steel. **Auto alignment** will still function in **commissioning** (press **enter** to return to **mode change** or **down** to go to **align time**).

Align Time

Align time. This is factory set to 4hrs, you can adjust this, by using the **right** and **left** keys, between **0** to **12 hours** depending on your environment (press **enter** to return to **mode change** or **down** to go to **green flashing light**).

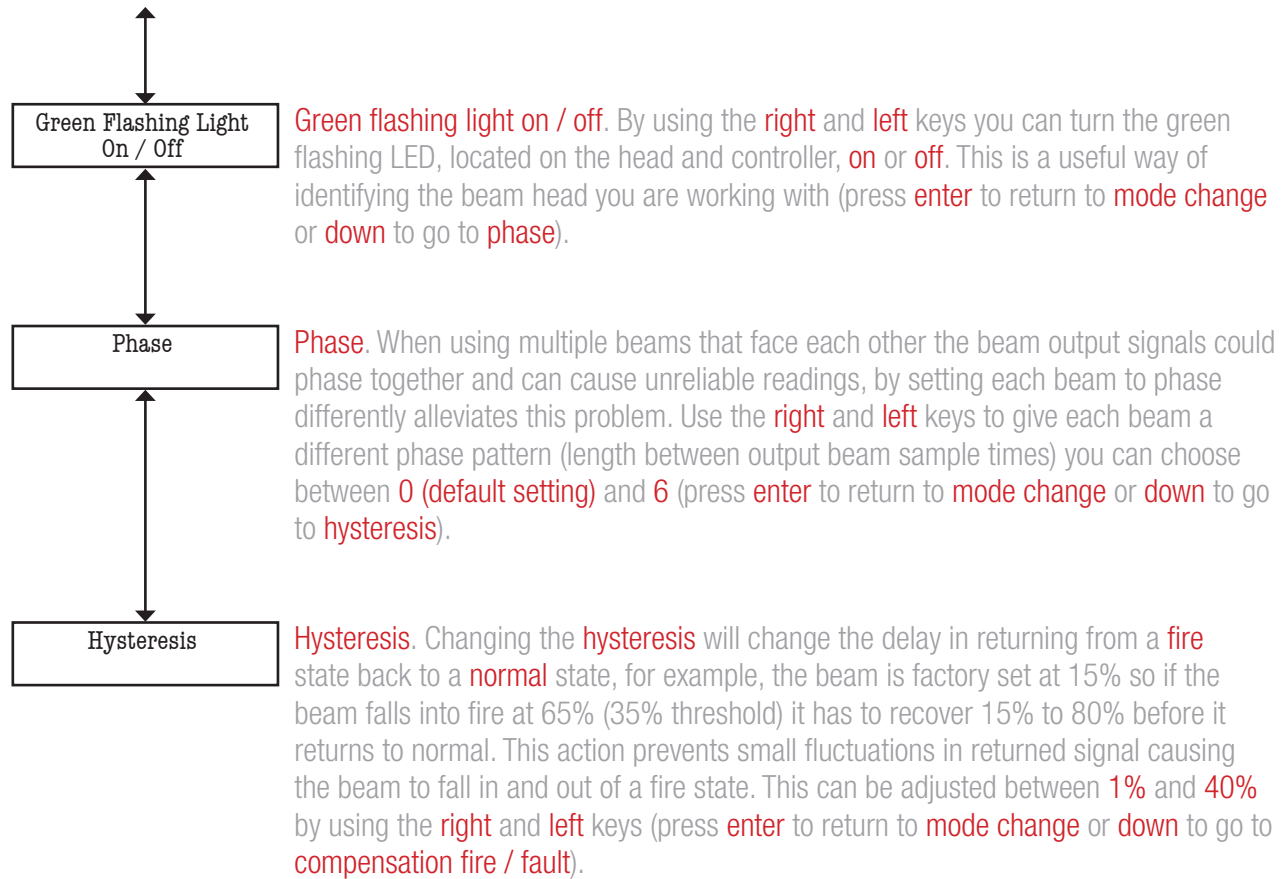

4. **Beam Maintenance** Press **enter**  to go into **beam maintenance**.

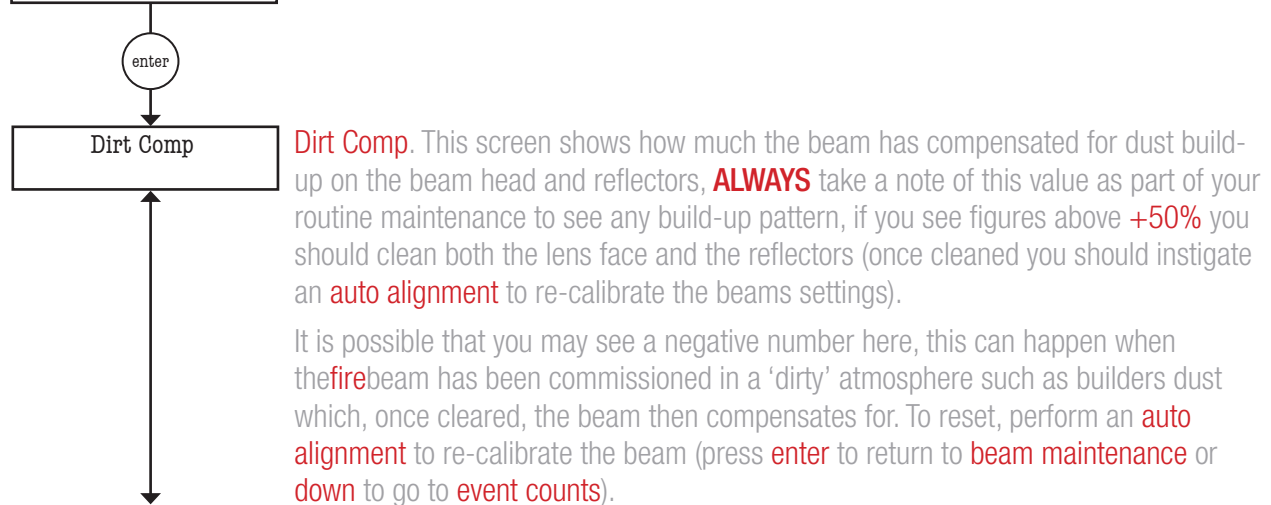

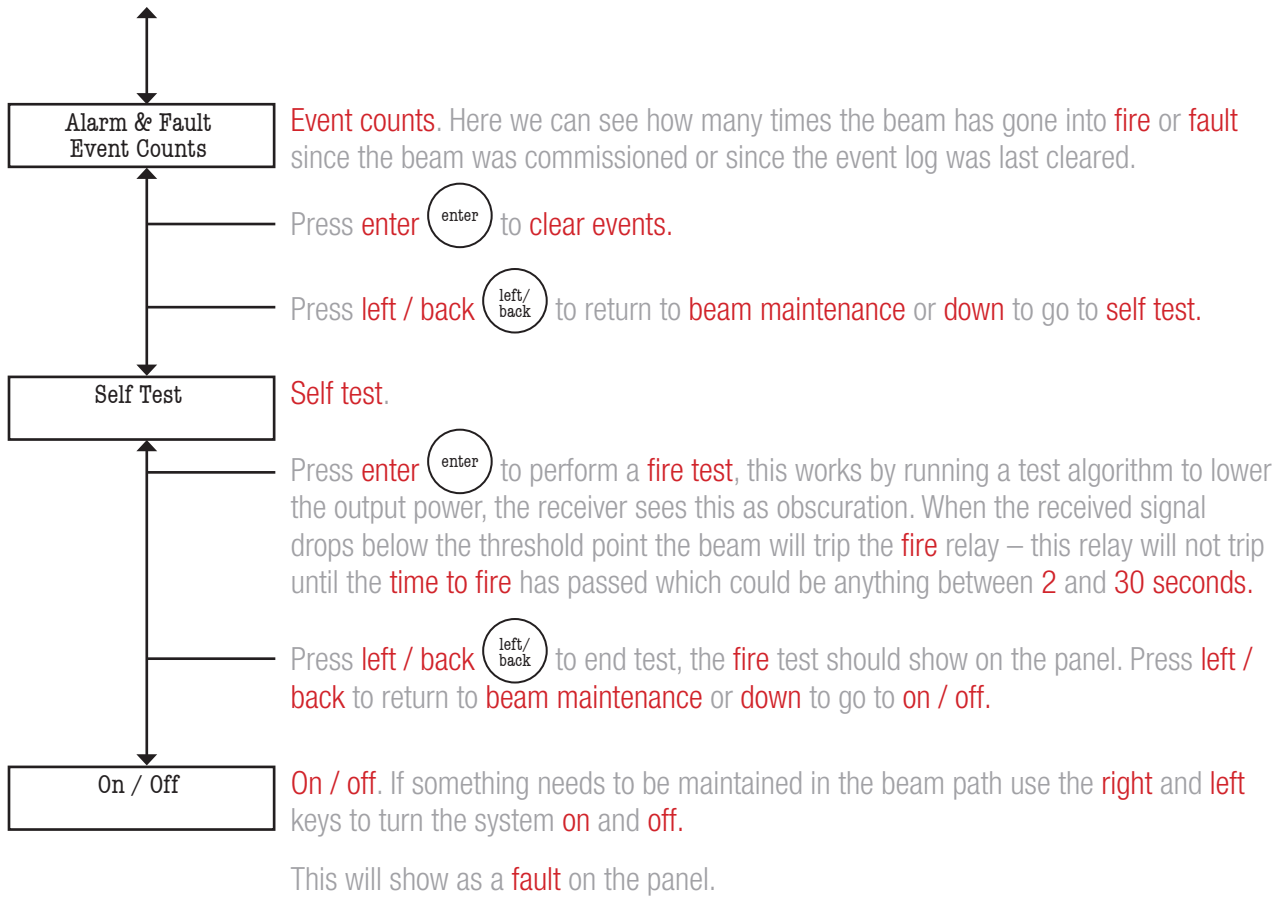

Press enter (enter) to return to beam maintenance.

5. **Diagnostics** Press enter (enter) to go into diagnostics.

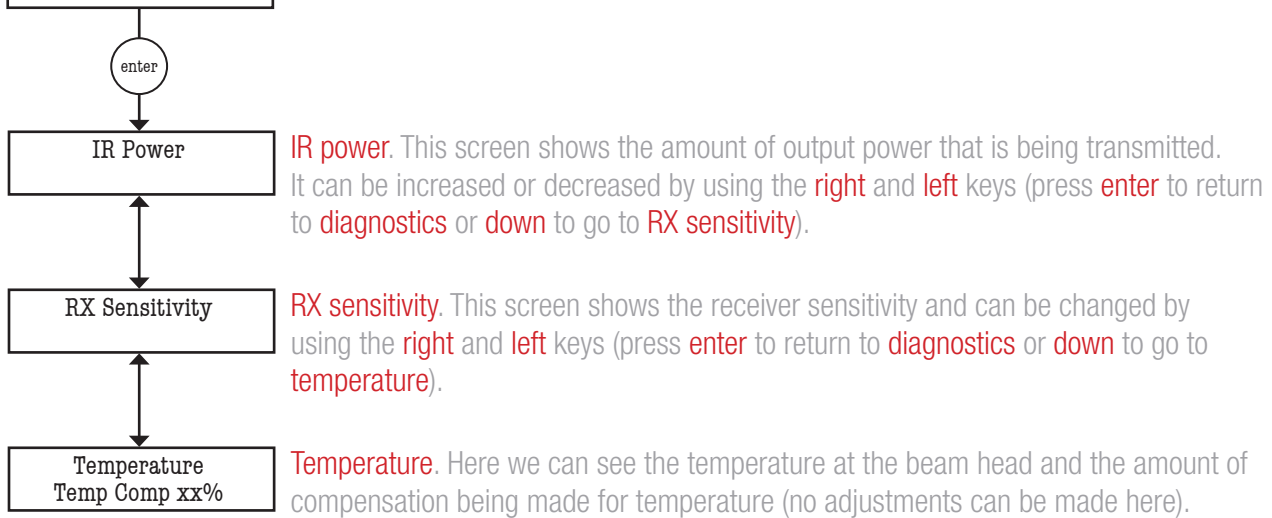

Press enter (enter) to return to diagnostics.

technical specifications

Electrical Specifications:

Supply Voltage. 10.2 to 40 VDC

Supply Current. 3.5mA (constant current) in all operational states

Constant Current. 17mA (constant current) in fast commissioning

Environmental Specifications:

Temperature. -10 C to +55 C

Humidity. 10 to 95% RH Non-condensing

Protection Index. IP65 when suitably mounted and terminated

Mechanical Specifications:

Beam Head.

180mmH x 155mmW x 137mmD
Weight 1.1Kg

Controller.

185mmH x 120mmW x 62mmD
Weight 0.55g

40KIT80 Mid-Range Reflector.

293mmH x 293mmW x 5mmD
Weight 0.8Kg

80KIT100 Long Range Reflector.

394mmH x 394mmW x 5mmD
Weight 1.8Kg

Adapter.

270mmH x 250mmW x 5mmD
Weight 0.6g
(mounts the Beam Head onto unistrut)

Optical Specifications:

Optical Wavelength. 870nm

Maximum Angular Alignment. ± 5

Maximum Angular Misalignment.
(static not auto-aligning)
Beam Head $\pm 0.3^\circ$ Reflector $\pm 2^\circ$

Operational Specifications:

Protection Range:

FIREBEAM.

Standard Product 5 to 40 metres

40KIT80.

Mid-Range Reflector Kit 40 to 80 metres

80KIT100.

Long Range Reflector Kit 80 to 100 metres

Alarm Sensitivity Levels:

25%(1.25dB) to 50%(3dB) in 1%(0.05dB) increments (default 35% (1.87dB))

Alarm Condition:

Obscuration drops to below pre-defined sensitivity level.
Time to Alarm Condition adjustable
2 to 30 seconds in 1 second increments (default 10 seconds)

Alarm Indication:

Controller Status FIRE
Controller Red Flashing LED
Head Red Flashing LED
Alarm Relay Change Over (CO) Contact
Rating 2A @ 30 VDC

Test/Reset Features:

Beam test function by controller
Alarm latching/auto-reset selectable (default auto-reset)
Alarm reset in latching mode by controller reset function, removing power for >5 seconds, apply 12 to 24 VDC to reset connections in Beam Head.

Fault Sensitivity Level:

90%

Fault Condition:

Obscuration drops to below the fault sensitivity level within 1 second
Power Down or Supply Voltage < 9 VDC
Commissioning modes, Pre-Alignment and Auto Alignment
Beam turned off during Beam Maintenance
Time to Fault Condition adjustable, 2 to 60 seconds in 1 second increments (default 10 seconds)

Fault Indication:

Controller Status FAULT
Controller Yellow Flashing LED 1 Second
Head Yellow Flashing LED 1 Second
Fault Relay Change Over (CO) Contact
Rating 2A @ 30 VDC

Normal Condition:

Obscuration level is above the Alarm sensitivity level
Controller Status NORMAL
Controller Green Flashing LED
Programmable on/off
Head Green Flashing LED
Programmable on/off

Auto-align/Beam Contamination Compensation:

Auto-align during normal operation if obscuration drops below 90% for the duration of the align time set (doesn't effect normal operating mode)
Beam Contamination Compensation 4 hour monitoring. Compensation data available at the controller